



Google Developer Student Clubs

K S School of Engineering and Management



# TALK TAPESTRY REPORT

PRESENTED BY





**"TalkTapestry: Threads of Insights"** is an innovative and dynamic event conceived to weave together the diverse experiences and invaluable insights of KSSEM's esteemed alumni with the current fabric of our student community. This event aims to create an interactive platform where knowledge, experiences, and wisdom interlace, forming a rich tapestry of learning and inspiration.

Through engaging talks, vibrant discussions, and interactive sessions, TalkTapestry seeks to unravel the threads of knowledge from successful KSSEM alumni, allowing them to impart their unique experiences, industry insights, and career trajectories. This event aspires to offer a mosaic of perspectives, providing our students with a comprehensive view of various domains and fostering a deeper understanding of the professional landscape beyond academia.

This event endeavors to bridge the gap between theoretical learning and practical wisdom, stitching together a collaborative environment that encourages dialogue, learning, and personal growth.





Google Developer Student Clubs



Google Developer Student Clubs



## TECH TALES UNVEILED RECAP OF TALKTAPESTRY MOMENTS

We are thrilled to present the post-event report for TalkTapestry, an event that successfully brought together the GDSC KSSEM community for a day filled with insights, entertainment, and camaraderie. This report captures the essence of each agenda item, showcasing the vibrant tapestry woven during the event.

### 1. Event Inauguration (10:45 am - 11:05 am):

Anchal Singh delivered a warm and inviting welcome speech, setting the stage for the day's proceedings. The event commenced with a solemn lamp lighting ceremony, symbolizing the illumination of knowledge. The invocation song set the tone for an engaging day ahead, capturing the spirit of unity and celebration.





Google Developer Student Clubs



## 2. Addressing by Principal and Token of Appreciation (11:05 am - 11:15 am):

The event was graced by the presence of Dr. Rama Narasimha-Principial KS School of Engineering and Management, Dr. B Balaji-HoD Mechanical Engineering, K Venkata Rao-HoD CSE, Manjunath T K-HoD AI&DS, Ramesh Babu N-HoD CS&BS, Dr. Vijayalakshmi Akella-HoD Civil Engineering, Dr. K Senthil Babu- HoD ECE, Dr. C Vasudev-HoD Basic Science, Dr. Ambika C A-Librarian, Dr.Harish R-Placement Officer, Roopa Balavenu-MBA Department, Amitha S-Faculty Advisor GDSC KSSEM and faculties.

The Principal addressed the gathering, sharing words of encouragement and highlighting the importance of such community events. A token of appreciation was presented to the HoDs, acknowledging their pivotal role in supporting GDSC KSSEM.





**3. Addressal by Vaishnavi (11:15 am - 11:50 am):**

Vaishnavi Dayanand-Lead GDSC KSSEM, with eloquence and passion, addressed the gathering, inspiring all with her words of wisdom and insights into the tech domain. Additionally a brief description of GDSC KSSEM's journey so far was presented.







#### 4. Addressal by Sameer Kashyap (11:50 am - 12:00 pm):

Sameer Kashyap captivated the audience with a compelling address, sharing industry experiences and valuable insights into the world of technology.





**5. Magic Show by Kishan (12:00 pm - 12:15 pm):**

Sai Kishan added a touch of magic and entertainment to the event, leaving the audience spellbound with his mesmerizing performance.





**6. Addressal by Sean Kevin (12:15 pm - 12:40 pm):**

Sean Kevin's address resonated with the audience, offering unique perspectives and inspiring thoughts on the evolving tech landscape.







**7. Quiz Hosted by Tamanna (12:40 pm - 1:10 pm):**

Tamanna Ahmad hosted an engaging quiz, challenging participants' knowledge and fostering a competitive yet fun atmosphere.





**8. Addressal by Riya Singh 1:10 pm - 1:30 pm):**

Riya Singh addressed the audience, and the momentous occasion of prize distribution added an extra layer of excitement, recognizing participants' achievements.







### 9. Panel Discussion (1:30 pm - 1:45 pm):

The panel discussion delved into insightful discussions, offering diverse perspectives on current tech trends and challenges.





**10. Vote of Thanks and Distribution of Stickers/Refreshments (1:45 pm - 1:55 pm):**

The event concluded with a heartfelt vote of thanks given by Sanjana S Vasista, expressing gratitude to all contributors. Stickers were distributed, adding a touch of memorabilia, and participants enjoyed refreshments as a delightful conclusion.







TalkTapestry, with its diverse agenda, was a resounding success, fostering knowledge exchange, community bonding, and entertainment. We express sincere gratitude to all participants, speakers, sponsors, and the organizing team for making this event memorable.



Google Developer Student Clubs



## CONCLUSION

TalkTapestry's success, witnessed through significant in-person attendance and positive engagement, highlights the resonance of collaborative learning in the tech community. The careful budget management, fueled by registration fees and generous support from the management, exemplifies our commitment to responsible event planning.

We extend heartfelt gratitude to management, principal, HoDs of all the departments, faculty advisor, attendees, speakers for their support and the GDSC KSSEM team for their dedication. As we conclude TalkTapestry, we celebrate the vibrant tapestry of ideas and connections woven during this event. The positive impact serves as a solid foundation for future endeavors, and we look forward to continued growth within the tech community.

Thank you for being part of this transformative journey.

**Warm regards,**

  
Lead, GDSC, KSSEM

  
Coordinator

  
Head of the Department

  
Principal

HOD, KS School of Engineering and Management  
Department of Computer Science Engineering  
KS School of Engineering & Management  
Bangalore - 560 109





**KSSEM**  
K. S. SCHOOL OF ENGINEERING AND MANAGEMENT

Kammavari Sangham (R) 1952

K. S. GROUP OF INSTITUTIONS

**K. S. SCHOOL OF ENGINEERING AND MANAGEMENT**

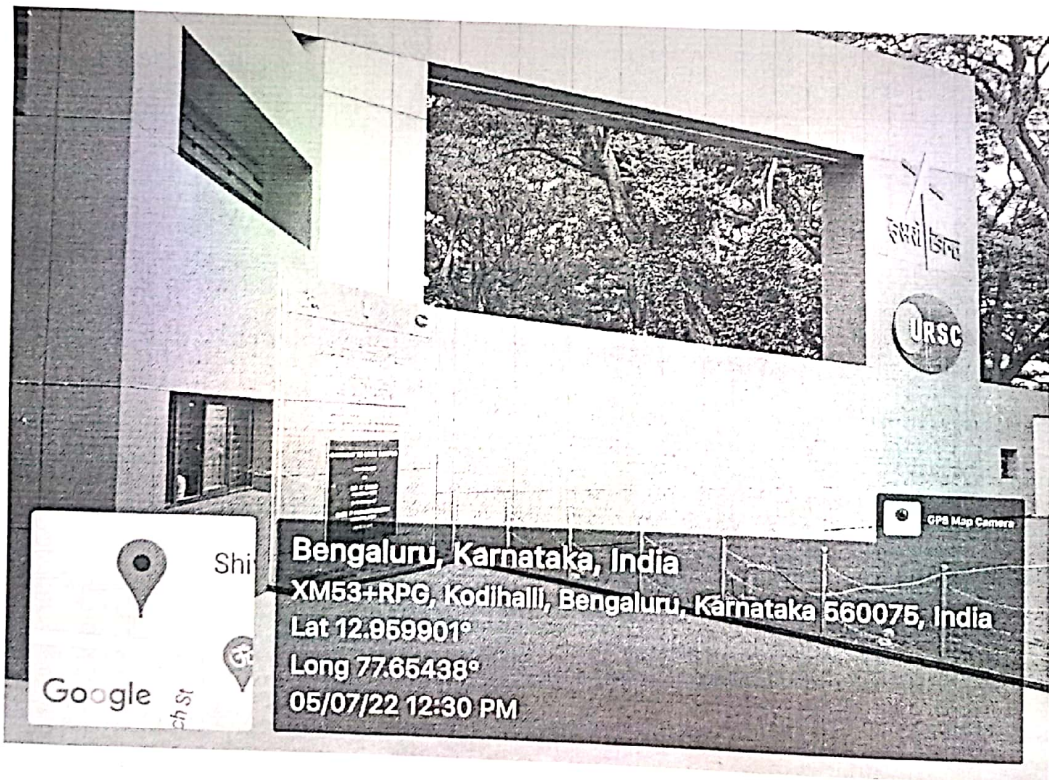
Approved by AICTE, New Delhi; Affiliated to VTU, Belagavi, Karnataka; Accredited by NAAC

www.kssem.edu.in

**DEPARTMENT OF ELECTRONICS AND COMMUNICATION ENGINEERING**

Report on  
INDUSTRIAL VISIT

Department of Electronics and Communication Engineering organized industrial visit to U R Rao Satellite Center to 6<sup>th</sup> Semester ECE students on 5<sup>th</sup> July 2022. The students visited exhibition center of satellite center and saw the various satellites developed by ISRO from Aryabhata, Bhaskara to till today. Mr. Srinivas has explained the various devices, fabrication and testing methods used in development of satellite and procedure of launching the satellite to space. Students were also taken to satellite manufacturing place (Window view). Mr. Puneeth. S, Mrs. Jayashree G R, Assistant Professor, Mr. Anil Kumar G P, Instructor, Department of ECE accompanied the students.





**KSSEM**  
K. S. SCHOOL OF ENGINEERING AND MANAGEMENT

Kammavari Sangham (R) 1952  
K. S. GROUP OF INSTITUTIONS

**K. S. SCHOOL OF ENGINEERING AND MANAGEMENT**  
Approved by AICTE, New Delhi; Affiliated to VTU, Belagavi, Karnataka; Accredited by NAAC

www.kssem.edu.in

**DEPARTMENT OF ELECTRONICS AND COMMUNICATION ENGINEERING**

U. R. RAO SATELLITE CENTRE  
HAL AIRPORT ROAD  
BANGALURU

**RECEPTION**

R / No. \_\_\_\_\_ Date: 05/07/22

Sl. No.	Name of the Visitors & Designation (in Capital letters)	Company Name & Full Address with Mobile No.
1	Prof. S. S. S. S.	K. S. School of
2	Dr. S. S. S. S.	Engineering &
3	Dr. K. S. S. S.	Management
4	47 Students	# 15, Malleshwara
5		Hf Bengaluru
6		Kodihalli, Bengaluru

Whom and Which Department to Visit: Industrial visit

Purpose of visit: \_\_\_\_\_

Nationality: Indian

Signature of the Visitor: \_\_\_\_\_

Signature of the Receptionist: \_\_\_\_\_

Vehicle to be Allowed: \_\_\_\_\_

Remarks: \_\_\_\_\_

Signature: \_\_\_\_\_  
(Shreyala Rathnakar)

Copy to: Administrative Officer (PRO), U. R. Rao Satellite Centre, Bangalore-17

Note: Route Map is attached herewith

Google  
HAL Old Air

**Bengaluru, Karnataka, India**  
**XM6S+MHM, Kodihalli, Bengaluru, Karnataka 560075, India**  
**Lat 12.96144°**  
**Long 77.654505°**  
**05/07/22 10:57 AM**

Figure: Entry Details at Reception of U R Rao Satellite Centre





**KSSEM**  
K. S. SCHOOL OF ENGINEERING AND MANAGEMENT

Kammavari Sangham (R) 1952  
K. S. GROUP OF INSTITUTIONS

**K. S. SCHOOL OF ENGINEERING AND MANAGEMENT**  
Approved by AICTE, New Delhi; Affiliated to VTU, Belagavi, Karnataka; Accredited by NAAC  
www.kssem.edu.in

**DEPARTMENT OF ELECTRONICS AND COMMUNICATION ENGINEERING**



Signature of HoD, ECE

Professor & Head  
Dept. of Electronics & Communication Engineering  
K. S. School of Engineering & Management





Kammavari Sangham (R) 1952  
K. S. GROUP OF INSTITUTIONS

**K. S. SCHOOL OF ENGINEERING AND MANAGEMENT**  
Approved by AICTE, New Delhi; Affiliated to VTU, Belagavi, Karnataka; Accredited by NAAC  
www.kssem.edu.in

**DEPARTMENT OF ELECTRONICS AND COMMUNICATION ENGINEERING**

---

Report on

"Brain Machine Interfaces & Machine Learning"

Date and Time : 7th July 2022 from 10.45AM to 12.45PM

Venue : Aryabhata Seminar Hall

Organized by: Department of Electronics and Communication Engineering, K. S. School of Engineering and Management, Bengaluru

Resource Person: Dr. K. Mahantesh, Associate Professor, Dept. of ECE, SJBIT, Bengaluru

Target Audience: 6<sup>th</sup> semester students of ECE (Both A & B Section)

**Scope and Objectives:**

This Guest Lecture focused on importance of booming technologies like Machine learning, Internet of Things and Artificial Intelligence.

This guest lecture on Brain Machine Interfaces & Machine Learning was organized for 6<sup>th</sup> semester students of Electronics & Communication Engineering. 70 students were present in the guest lecture. Speaker informed about importance of supervised and unsupervised learning in artificial intelligence. He also informed the significant differences between classification and regression. He also mentioned the usage of continual and zero shot learning in artificial intelligence. Students were benefited learning about different types of technologies which are existing in the market.

Lots of questions were asked at the end of speaker's presentation. Speaker answered all the queries asked by the participants. Speaker discussed about current technologies







Kammavari Sangham (R) 1952  
K. S. GROUP OF INSTITUTIONS

**K. S. SCHOOL OF ENGINEERING AND MANAGEMENT**  
Approved by AICTE, New Delhi; Affiliated to VTU, Belagavi, Karnataka; Accredited by NAAC

www.kssem.edu.in

**KSSEM**

**DEPARTMENT OF ELECTRONICS AND COMMUNICATION ENGINEERING**

and accuracy related issues in machine learning and artificial intelligence. 70 students were present in the guest lecture.



Fig A: Screenshot-1 of guest lecture



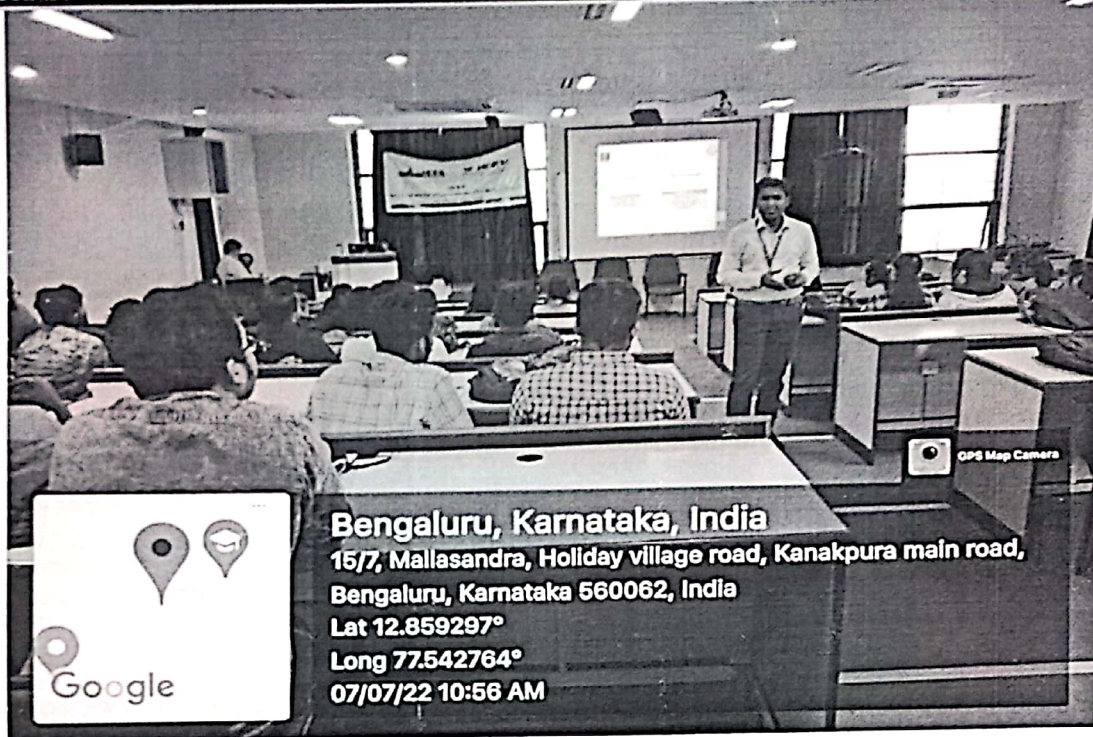
Kammavari Sangham (R) 1952  
K. S. GROUP OF INSTITUTIONS

**K. S. SCHOOL OF ENGINEERING AND MANAGEMENT**  
Approved by AICTE, New Delhi; Affiliated to VTU, Belagavi, Karnataka; Accredited by NAAC  
www.kssem.edu.in



**DEPARTMENT OF ELECTRONICS AND COMMUNICATION ENGINEERING**

of-2 of



guest lecture



Kammavari Sangham (R) 1952, K. S. Group of Institutions

**K. S. SCHOOL OF ENGINEERING AND MANAGEMENT**

No.15, Mallasandra, Off Kanakapura Road, Bengaluru-560109  
Affiliated to VTU, Belagavi & Approved by AICTE, New Delhi. Accredited by NAAC



**Department of Electronics & Communication Engineering**

Presents Guest Lecture on

**“Brain Machine Interfaces & Machine Learning”**

**Speaker:**

Dr. Mahantesh K,  
Associate Professor, Dept. of ECE,  
S.J.B Institute of Technology, Bengaluru.

Date : July 7<sup>th</sup>, 2022

Time : 10.45am to 12.35pm

Venue : Aryabhata Seminar Hall

**Event Coordinator**

Mr. Dileep J  
Assistant Professor, Dept. of ECE

**Conveners**

Dr. Girish V. Attimarad  
Professor & Head, Dept. of ECE

**Patron**

Dr. K. Rama Narasimha  
Principal/Director

Fig C: Guest Lecture Poster







Kammavari Sangham (R) 1952

K. S. GROUP OF INSTITUTIONS

**K. S. SCHOOL OF ENGINEERING AND MANAGEMENT**

Approved by AICTE, New Delhi; Affiliated to VTU, Belagavi, Karnataka; Accredited by NAAC

www.kssem.edu.in



**DEPARTMENT OF ELECTRONICS AND COMMUNICATION ENGINEERING**


### Mapping of webinar with PO'S and PSO'S

Program	PO1	PO2	PO3	PO4	PO5	PO6	PO7	PO8	PO9	PO10	PO11	PO12	PSO1
Guest Lecture	2	2	1	1	-	-	-	-	2	1	2	2	2

- PO1: Participants gained the knowledge of engineering fundamentals of artificial intelligence.
- PO2: Participants can be able to analyze complex engineering problems related to machine learning.
- PO3: Participants can be able to apply the knowledge in using various classification algorithms.
- PO4: Participants can identify complex problems for research work.
- PO9: Participants understands the benefit of Team work
- PO10: Participants can communicate effectively by gaining knowledge.
- PO11: Participants understood the requirements in doing project work
- PO12: Participants can apply the basic knowledge in lifelong learning of new programming skills in artificial intelligence.
- PSO1: Participants are able to understand and apply machine learning concepts to various fields of signal communication problems.

Report Submitted By

Mr. Dileep J  
Dept. of ECE

  
Signature of HoD, ECE

Professor & Head  
Dept. of Electronics & Communication Engineering  
K. S. School of Engineering & Management  
Bangalore-560 109





**KSSEM**  
K.S. SCHOOL OF ENGINEERING AND MANAGEMENT

Kammavari Sangham (R) 1952

K. S. GROUP OF INSTITUTIONS

**K. S. SCHOOL OF ENGINEERING AND MANAGEMENT**

Approved by AICTE, New Delhi; Affiliated to VTU, Belagavi, Karnataka; Accredited by NAAC

www.kssem.edu.in

**DEPARTMENT OF ELECTRONICS AND COMMUNICATION ENGINEERING**

## Report on Teacher's Day Celebration



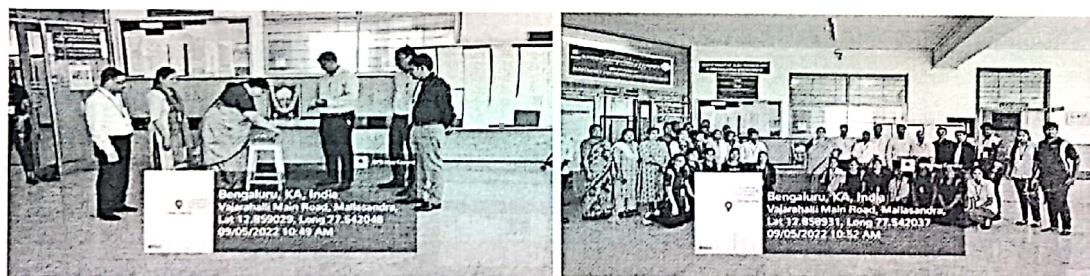
The IEEE KSSEM student Branch has organized Teacher's Day celebration on 5th September 2022 on behalf of Dept. of ECE in association with IEEE Bangalore section.

Teacher's day event is celebrated on 5<sup>th</sup> September every year on the occasion of birth of **Dr. Sarepalli Radhakrishnan's**.

Small function was organized by IEEE KSSEM Student Branch in our college on this occasion for our teachers.

Teacher's day event started at 10:30 am. The function started with lighting of lamp in front of Dr Sarepalli Radhakrishnan's photo. All the department HoD's, teachers and students attended the function. We did a small cake cutting ceremony. Cake was distributed to all the teachers and students. The day was filled with lot of excitements, joy and happiness.

### PHOTO GALLERY



  
Signature of the HoD, ECE.

Professor & Head  
Dept. of Electronics & Communication Engineering  
K. S. School of Engineering & Management  
Bangalore-560 109







Kammavari Sangham (R) 1952

K. S. GROUP OF INSTITUTIONS

# K. S. SCHOOL OF ENGINEERING AND MANAGEMENT

Approved by AICTE, New Delhi; Affiliated to VTU, Belagavi, Karnataka; Accredited by NAAC

www.kssem.edu.in



DEPARTMENT OF ELECTRONICS AND COMMUNICATION ENGINEERING

## Report on Engineer's Day Celebration

The Department of Electronics and Communication Engineering, KSSEM organized Engineer's Day celebration on 15th September 2022. Engineers play a crucial role in the development of a nation.

Engineer's Day is celebrated on 15<sup>th</sup> September every year on the occasion of birth anniversary of Sir. Mokshagundam Visvesvaraya.

Sir M Visvesvaraya was the Diwan of Mysore from 1912 to 1918; he was the brain behind the Krishna Raja Sagar Dam in Mysore as well as Chief Designer of the Flood Protection System for the city of Hyderabad. In 2018 Google has paid tribute to the Engineering Legend Sir M V with a doodle.

Engineer's Day celebration started at 10:00am with lighting of lamp in front of Sir. Mokshagundam Visvesvaraya photo. Our beloved Principal Sir, Dr. K Ramanarasimha and HoD, Dr. Girish V Attimarad along with all the Teaching and Non-Teaching Staff Members participated in the celebration.



*[Handwritten Signature]*  
**Signature of the HoD, ECE.**

Professor & Head

Dept. of Electronics & Communication Engineering

K. S. School of Engineering & Management

Bangalore-560 109





Kammavari Sangham (R) 1952  
K. S. GROUP OF INSTITUTIONS

**K. S. SCHOOL OF ENGINEERING AND MANAGEMENT**  
Approved by AICTE, New Delhi; Affiliated to VTU, Belagavi, Karnataka; Accredited by NAAC

www.kssem.edu.in



**DEPARTMENT OF ELECTRONICS AND COMMUNICATION ENGINEERING**

### Ayudha Pooja celebration 2022-23

Department of Electronics and Communication Engineering have celebrated Ayudha Pooja on account of Vijayadashami on 3<sup>rd</sup> October 2022 at 12 PM. Dr. K. Ramanarasimha, Principal, KSSEM, Dr. Girish V. Attimarad, Professor and Head of the Department ECE along with HoD's of various departments and all other faculties and supporting staff with students participated in Pooja to seek the blessings of Maa Durga. Entire department including Laboratories, staff rooms and class rooms were cleaned and sanitized on eve of this festival. Pooja was setup at DSP Lab by attenders Mrs. Geetha and Mr. Sateesh.

Pooja was organized and coordinated by all lady staff of the department. Sweets and fruits were offered to Maa Durga. Devotional songs and Sanskrit Mantras were recited. Finally the event was concluded by sweet distribution.



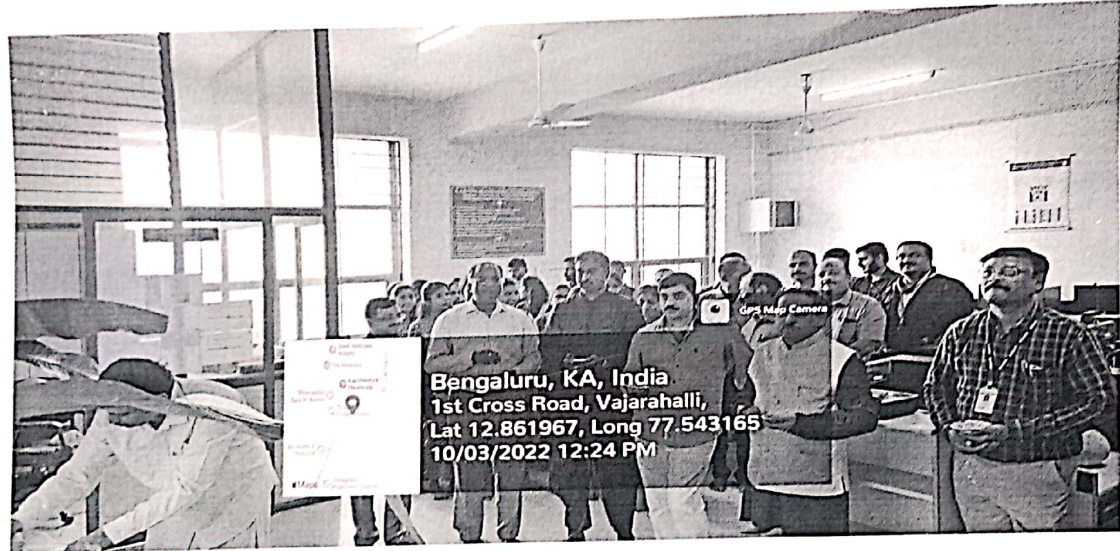


**K. S. SCHOOL OF ENGINEERING AND MANAGEMENT**

Approved by AICTE, New Delhi; Affiliated to VTU, Belagavi, Karnataka; Accredited by NAAC

www.kssem.edu.in

**DEPARTMENT OF ELECTRONICS AND COMMUNICATION ENGINEERING**



*R. Tali*  
Mrs. Renuka V Tali  
Coordinator  
Department of ECE  
KSSEM

*Girish V. Attimarad*  
Dr. Girish V. Attimarad  
Professor and Head  
Department ECE  
KSSEM  
**Professor & Head**  
Dept. of Electronics & Communication Engineering  
K. S. School of Engineering & Management  
Bangalore-560 109

*K. Rama Narasimha*  
Dr. K. RAMANARASIMHA  
**Dr. K. RAMA NARASIMHA**  
Principal / Director  
K S School of Engineering and Management  
KSSEM  
Bengaluru - 560 109



**KSSEM**  
K. S. SCHOOL OF ENGINEERING AND MANAGEMENT

KammavariSangham (R) 1952

K. S. GROUP OF INSTITUTIONS

**K. S. SCHOOL OF ENGINEERING AND MANAGEMENT**

Approved by AICTE, New Delhi; Affiliated to VTU, Belagavi, Karnataka; Accredited by NAAC

www.kssem.edu.in

**DEPARTMENT OF ELECTRONICS AND COMMUNICATION ENGINEERING**

---

## REPORT ON CHARACTERISATION & PERFORMANCE-TUNING OF IMAGING SYSTEMS'

Organized by IEEE Student Branch, KSSEM



In association with IEEE Bangalore section

**Event name:** Characterization & Performance-Tuning of Imaging Systems

**Date of event:** 15<sup>th</sup> October, 2022

**Venue:** Aryabhatta Seminar Hall, Dept. of ECE, KSSEM

**Number of participants:** 60

**Targeted Audience:** ECE & EEE Students of all semesters.

The IEEE Student branch in association with the ECE department, of KSSEM, had organized a technical talk on, "**Characterization & Performance-Tuning of Imaging Systems**" on 15<sup>th</sup> October 2022 at 11:00 am. The seminar was conducted at K.S School of Engineering & Management, Bangalore. The talk was delivered by **Mr. Vaishnav Ram**, Research Engineer at Siemens Healthiness and alumni of KSSEM & IIT-B. Dr. Girish V Attimarad, HoD of ECE, & Dr. Karthik P, branch counsellor of IEEE KSSEM SB graced the event with their presence. The seminar was attended by both faculty members and students. Mr. Vaishnav Ram gave a brief introduction of Imaging Systems and their applications. Imaging systems are devices used for the purpose of measuring position, momentum, energy, or mass of charged particles.







**KSSEM**

Kannavarihangam (R) 1952

K. S. GROUP OF INSTITUTIONS

**K. S. SCHOOL OF ENGINEERING AND MANAGEMENT**

Approved by AICTE, New Delhi; Affiliated to VTU, Belagavi, Karnataka; Accredited by NAAC

www.ksssem.edu.in

**DEPARTMENT OF ELECTRONICS AND COMMUNICATION ENGINEERING**

Microscopes provide detailed information of initial positions by magnifying these into more easily measurable final conditions. Imaging systems play a vital role in Medical-Electronic devices. The speaker also explicated about Characterization of images. An image refers to any pictorial representation, regardless of what wavelengths or remote sensing device has been used to detect and record the electromagnetic energy. The characteristics of an image make it possible to describe the properties of an image obtained through a light phenomenon such as reflection or refraction. The speaker then elaborated on, performance tuning of imaging systems. A quality image does not mean a sharp, bright image with high contrast. Image quality (IQ) is a critical issue that encompasses much more than brightness and sharpness. Several factors contribute significantly to the quality of the image a camera delivers. A large amount of math and processing is involved when the camera takes the light from your sensor and transforms it into a good-looking picture.

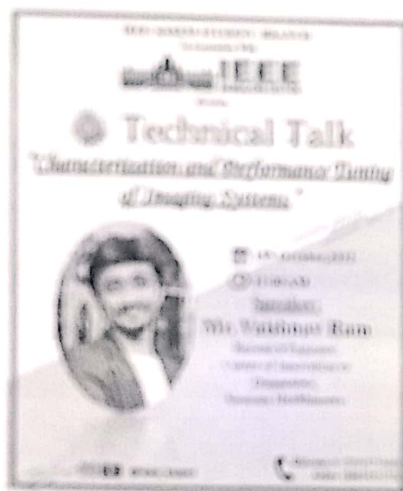


Fig 1: Inauguration of Event



**KSSEM**

KammavariSangham (R) 1952

K. S. GROUP OF INSTITUTIONS

**K. S. SCHOOL OF ENGINEERING AND MANAGEMENT**


Approved by AICTE, New Delhi; Affiliated to VTU, Belagavi, Karnataka; Accredited by NAAC

www.kssem.edu.in

**DEPARTMENT OF ELECTRONICS AND COMMUNICATION ENGINEERING**



Fig 2: Faculties, 7<sup>th</sup> SEM students and 5<sup>th</sup> SEM students who were present in the event

  
Signature of HOD, ECE

Professor & Head  
Dept. of Electronics & Communication Engineering  
K. S. School of Engineering & Management  
Bangalore-560 109







**KSSEM**  
K.S. SCHOOL OF ENGINEERING AND MANAGEMENT

KammavariSangham (R) 1952

K. S. GROUP OF INSTITUTIONS

**K. S. SCHOOL OF ENGINEERING AND MANAGEMENT**

Approved by AICTE, New Delhi; Affiliated to VTU, Belagavi, Karnataka; Accredited by NAAC

www.kssem.edu.in

**DEPARTMENT OF ELECTRONICS AND COMMUNICATION ENGINEERING**

---

### Technical Talk on Emerging Technology

Department of Electronics and Communication Engineering organized a technical talk on emerging technologies to the faculties of ECE, 5<sup>th</sup> semester and 7<sup>th</sup> semester students on 21/10/2022 at 11AM in Aryabhata seminar hall.

#### Emerging Technology

Emerging technologies are technologies whose development, practical applications, or both are still largely unrealized. These technologies are generally new but also include older technologies finding new applications.

New technological fields may result from the technological convergence of different systems evolving towards similar goals. Convergence brings previously separate technologies such as voice (and telephony features), data (and productivity applications) and video together so that they share resources and interact with each other, creating new efficiencies.

#### Ethnus

Ethnus is basically the ability to understand people's motivations. Ethnus integrates industry-certified training in emerging technologies like Cloud Computing, IoT, Cyber Security, Full Stack, and more with hands-on learning, projects, and placement guidance - all in a seamless experience geared to make students proficient.

#### Sales Force

Sales force is a powerful CRM platform that allows businesses to manage all their sales, marketing, and communication services in one place. Sales force developers are responsible for developing new sales force apps to meet company objectives and provide scalable processes.

Dr Girish V Attimarad, HOD, Dept of ECE, KSSEM, faculties of ECE department, 5<sup>th</sup> and 7<sup>th</sup> semester students was present for the technical talk. Mr Gowtham addressed them and gave a brief on the recent emerging technologies.





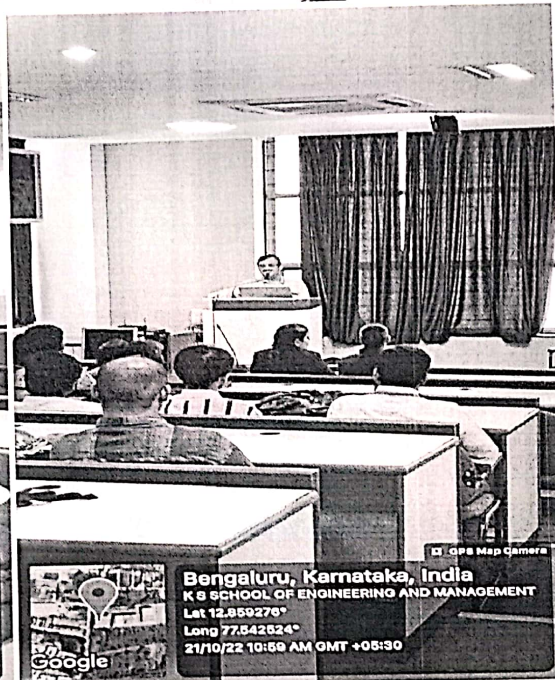
**KSSEM**  
K.S. SCHOOL OF ENGINEERING AND MANAGEMENT

KammavariSangham (R) 1952  
K. S. GROUP OF INSTITUTIONS

**K. S. SCHOOL OF ENGINEERING AND MANAGEMENT**  
Approved by AICTE, New Delhi; Affiliated to VTU, Belagavi, Karnataka; Accredited by NAAC  
www.kssem.edu.in

**DEPARTMENT OF ELECTRONICS AND COMMUNICATION ENGINEERING**

Photo Gallery:





REMENT  
NAAC



**KSSEM**  
KARNATAKA SCHOOL OF ENGINEERING AND MANAGEMENT

KammavariSangham (R) 1952

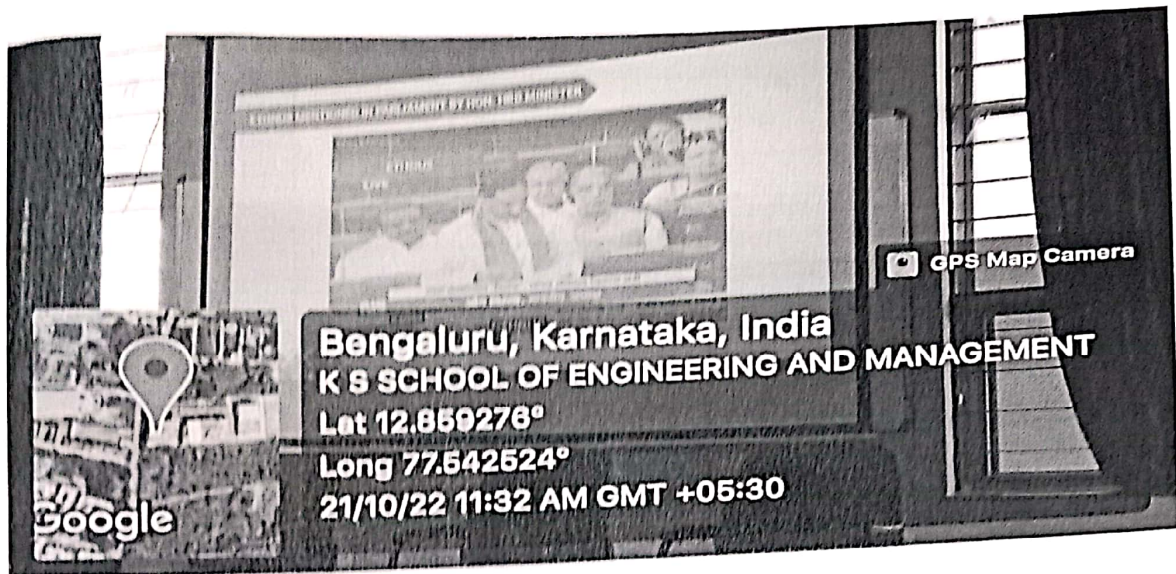
K. S. GROUP OF INSTITUTIONS

**K. S. SCHOOL OF ENGINEERING AND MANAGEMENT**

Approved by AICTE, New Delhi; Affiliated to VTU, Belagavi, Karnataka; Accredited by NAAC

www.kssem.edu.in

**DEPARTMENT OF ELECTRONICS AND COMMUNICATION ENGINEERING**



  
Signature of HOD, ECE

Professor & Head  
Dept. of Electronics & Communication Engineering  
K. S. School of Engineering & Management  
Bangalore-560 109





**KSSEM**  
K. S. SCHOOL OF ENGINEERING AND MANAGEMENT

KammavariSangham (R) 1952

K. S. GROUP OF INSTITUTIONS

**K. S. SCHOOL OF ENGINEERING AND MANAGEMENT**

Approved by AICTE, New Delhi; Affiliated to VTU, Belagavi, Karnataka; Accredited by NAAC

www.kssem.edu.in

**DEPARTMENT OF ELECTRONICS AND COMMUNICATION ENGINEERING**

## Workshop on

### Innovation Harvesting and IP Protection

Department of Electronics and Communication Engineering organized a work shop on Innovation harvesting and IP protection to all the faculties from various departments of KSSEM on 4<sup>th</sup> November 2022 in architecture seminar hall. Mr Jayachandra Aradhya and Dr Cyril prasanna Raj P conducted the workshop and gave a brief idea about innovation and patent. Various activities were conducted to all the faculties to make them understand about patents. HODs of various department and faculties from various department of KSSEM participated in the workshop.

### **Innovation**

Innovation is the practical implementation of ideas that result in the introduction of new goods or services or improvement in offering goods or services.

Innovation often takes place through the development of more-effective products, processes, services, technologies, art works or business models that innovators make available to markets, governments and society. Innovation is related to, but not the same as, invention. Innovation is more apt to involve the practical implementation of an invention (i.e. new / improved ability) to make a meaningful impact in a market or society, and not all innovations require a new invention.

### **Creativity and innovation**

In general, innovation is distinguished from creativity by its emphasis on the implementation of creative ideas in an economic setting. Amabile and Pratt in 2016, drawing on the literature, distinguish between creativity ("the production of novel and useful ideas by an individual or small group of individuals working together") and innovation.

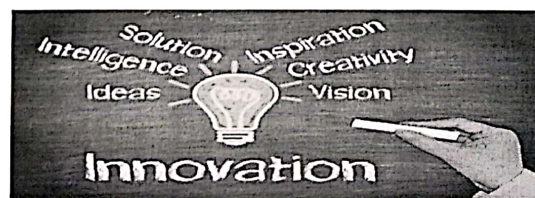


Fig: Key steps for innovation





**KSSEM**  
K. S. SCHOOL OF ENGINEERING AND MANAGEMENT

KammavariSangham (R) 1952

K. S. GROUP OF INSTITUTIONS

**K. S. SCHOOL OF ENGINEERING AND MANAGEMENT**  
Approved by AICTE, New Delhi; Affiliated to VTU, Belagavi, Karnataka; Accredited by NAAC  
www.kssem.edu.in

**DEPARTMENT OF ELECTRONICS AND COMMUNICATION ENGINEERING**

## Patent

A patent is a type of intellectual property that gives its owner the legal right to exclude others from making, using, or selling an invention for a limited period of time in exchange for publishing an enabling disclosure of the invention. In most countries, patent rights fall under private law and the patent holder must sue someone infringing the patent in order to enforce their rights.

### Types of Patent

- 1) **Utility patent.** This is what most people think of when they think about a patent. It's a long, technical document that teaches the public how to use a new machine, process, or system. The kinds of inventions protected by utility patents are defined by Congress. New technologies like genetic engineering and internet-delivered software are challenging the boundaries of what kinds of inventions can receive utility patent protection.
- 2) **Design patent.** This patent offer protection for an ornamental design on a useful item. The shape of a bottle or the design of a shoe, for example, can be protected by a design patent. The document itself is almost entirely made of pictures or drawings of the design on the useful item. Design patents are notoriously difficult to search simply because there are very few words used in a design patent. In recent years, software companies have used design patents to protect elements of user interfaces and even the shape of touch screen devices.

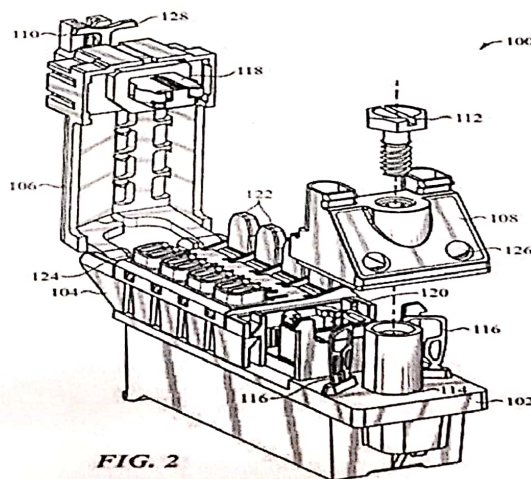


FIG. 2





KammavariSangham (R) 1952  
K. S. GROUP OF INSTITUTIONS

# K. S. SCHOOL OF ENGINEERING AND MANAGEMENT

Approved by AICTE, New Delhi; Affiliated to VTU, Belagavi, Karnataka; Accredited by NAAC

www.kssem.edu.in



DEPARTMENT OF ELECTRONICS AND COMMUNICATION ENGINEERING

## Photo Gallery:





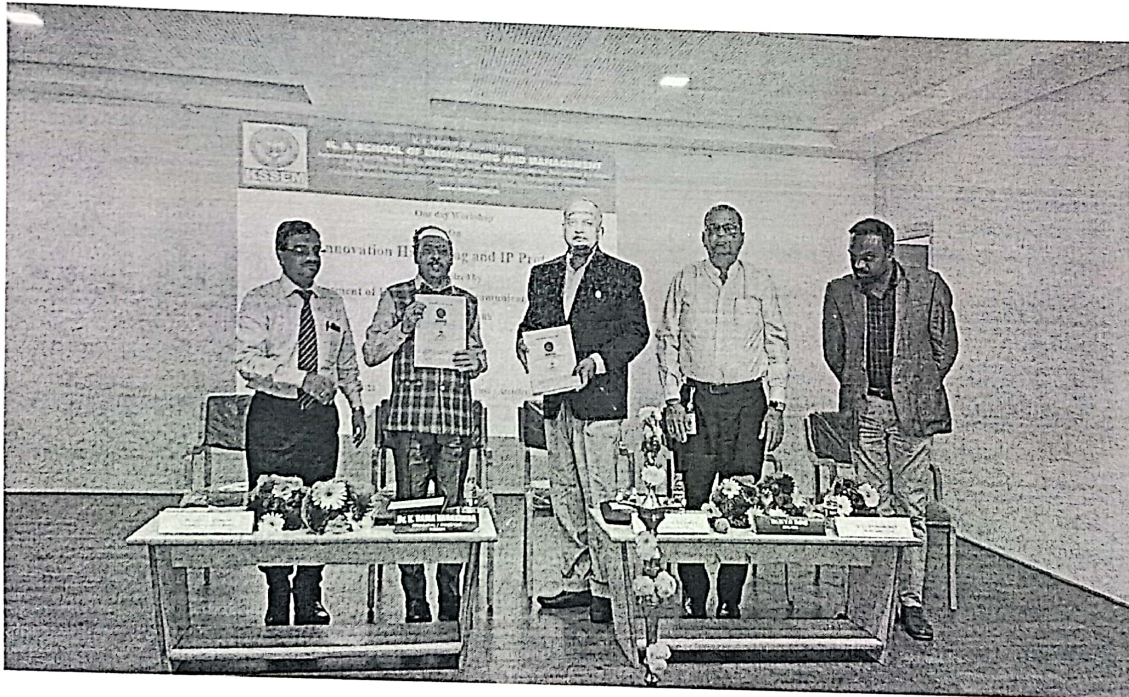
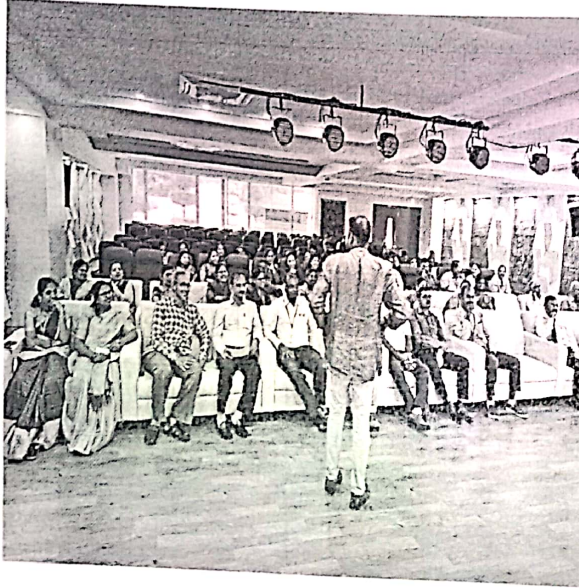


**KSSEM**  
K.S. SCHOOL OF ENGINEERING AND MANAGEMENT

KammavariSangham (R) 1952  
K. S. GROUP OF INSTITUTIONS

**K. S. SCHOOL OF ENGINEERING AND MANAGEMENT**  
Approved by AICTE, New Delhi; Affiliated to VTU, Belagavi, Karnataka; Accredited by NAAC  
www.kssem.edu.in

**DEPARTMENT OF ELECTRONICS AND COMMUNICATION ENGINEERING**







**KSSEM**  
K. S. SCHOOL OF ENGINEERING AND MANAGEMENT

KammavariSangham (R) 1952

K. S. GROUP OF INSTITUTIONS

**K. S. SCHOOL OF ENGINEERING AND MANAGEMENT**

Approved by AICTE, New Delhi; Affiliated to VTU, Belagavi, Karnataka; Accredited by NAAC

www.kssem.edu.in

**DEPARTMENT OF ELECTRONICS AND COMMUNICATION ENGINEERING**



  
Signature of HOD, ECE

Professor & Head

Dept. of Electronics & Communication Engineering  
K. S. School of Engineering & Management  
Bangalore-560 109





**KSSEM**  
K.S. GROUP OF INSTITUTIONS  
BANGALORE

KammavariSangham (R) 1952

**K. S. GROUP OF INSTITUTIONS**

**K. S. SCHOOL OF ENGINEERING AND MANAGEMENT**  
Approved by AICTE, New Delhi; Affiliated to VTU, Belagavi, Karnataka; Accredited by NAAC  
www.kssem.edu.in

**DEPARTMENT OF ELECTRONICS AND COMMUNICATION ENGINEERING**

Report on

Industrial Visit to Tech Summit-2022

Department of Electronics and Communication Engineering organized industrial visit to Tech Summit which was organized in Palace Grounds to 3<sup>rd</sup> Semester ECE students on 18<sup>th</sup> November 2022.

STPI co-hosted the 25<sup>th</sup> (Silver Jubilee) edition of BENGALURU TECH SUMMIT organized by Department of Information Technology, Biotechnology and Science & Technology, Government of Karnataka from 16<sup>th</sup> Nov to 18<sup>th</sup> Nov 2022 which was held at Bangalore palace.

The students visited exhibition centre and they came to know about the various start up companies that are incubated with Government of Karnataka. Also students learnt about the innovative products/solutions developed are multi-disciplinary and are sector- agnostic ranging from IT/ITeS, Agri-Tech, Med-Tech, Health care, Clean-Tech, Artificial Intelligence (AI), Edu-Tech, Block chain, IoT, Cyber security, EV and ESDM. Also management effluent water treatment and so on. Mrs. Bhargavi Vijendra Sangam, Assistant Professor, Mrs. Vijayalakshmi C Kalal, Assistant Professor, Mr. Anil Kumar G P, Instructor, Mr Sathish, Attendar, Department of ECE accompanied the students.

**Photo Gallery:**



**Fig: Industrial Visit to Tech Summit-2022**







**KSSEM**  
K. S. GROUP OF INSTITUTIONS

KammavariSangham (R) 1952  
K. S. GROUP OF INSTITUTIONS

**K. S. SCHOOL OF ENGINEERING AND MANAGEMENT**  
Approved by AICTE, New Delhi; Affiliated to VTU, Belagavi, Karnataka; Accredited by NAAC  
www.kssem.edu.in


**DEPARTMENT OF ELECTRONICS AND COMMUNICATION ENGINEERING**



Fig: 3<sup>rd</sup> Semester Students Involved in Explanation



Fig: Faculty and Students in Tech Summit-2022

  
Signature of HOD, ECE

Professor & Head  
Dept. of Electronics & Communication Engineering  
K. S. School of Engineering & Management  
Bangalore-560 109



**KSSEM**  
K. S. SCHOOL OF ENGINEERING AND MANAGEMENT

KammavariSangham (R) 1952

**K. S. GROUP OF INSTITUTIONS**

**K. S. SCHOOL OF ENGINEERING AND MANAGEMENT**  
Approved by AICTE, New Delhi; Affiliated to VTU, Belagavi, Karnataka; Accredited by NAAC  
www.kssem.edu.in

**DEPARTMENT OF ELECTRONICS AND COMMUNICATION ENGINEERING**

### Report on

### VTU Inter College Kabaddi Tournament- 2022

The Students of Department of Electronics and Communication Engineering Participated in VTU inter college Kabaddi Tournament which was organized in K S School of Engineering and Management on 3/11/2022 to 4/11/2022.

Games and sports are an integral part of a student's life. A student should study hard to be successful in competitive examinations. But, he/ she should also play games and sports to enjoy the health and vigor of life. In this Tournament totally 22 colleges participated and the colleges were given the participation certificate.

Swamy M, Jetti Bheemesh, Nithin G N, Nishanth M, Supreeth R, Students of K S School of Engineering and Management also participated in the tournament and they were awarded with the participation certificate.

#### **Photo Gallery:**



**Fig:** Students of KSSEM, ECE department awarded with participation certificate





**KSSEM**  
K. S. SCHOOL OF ENGINEERING AND MANAGEMENT

KammavariSangham (R) 1952

K. S. GROUP OF INSTITUTIONS

**K. S. SCHOOL OF ENGINEERING AND MANAGEMENT**

Approved by AICTE, New Delhi; Affiliated to VTU, Belagavi, Karnataka; Accredited by NAAC

www.kssem.edu.in

**DEPARTMENT OF ELECTRONICS AND COMMUNICATION ENGINEERING**



Fig: Management of KSSEM, Principal of KSSEM, HODs of Various department, Students of KSSEM at the Venue of Tournament.

  
Signature of HOD, ECE

Professor & Head  
Dept. of Electronics & Communication Engineering  
K. S. School of Engineering & Management  
Bangalore-560 109







**KSSEM**

Kammavari Sangham (R) 1952  
K. S. GROUP OF INSTITUTIONS

**K. S. SCHOOL OF ENGINEERING AND MANAGEMENT**  
Approved by AICTE, New Delhi; Affiliated to VTU, Belagavi, Karnataka; Accredited by NAAC  
www.kssem.edu.in

**DEPARTMENT OF ELECTRONICS AND COMMUNICATION ENGINEERING**

## Report on Industrial Visit to "DIVYA ENTERPRISES"

Date of Industrial Visit: 08/12/2022

Organized by: Department of Electronics & Communication Engineering, K.S  
School of Engineering and Management, Bengaluru

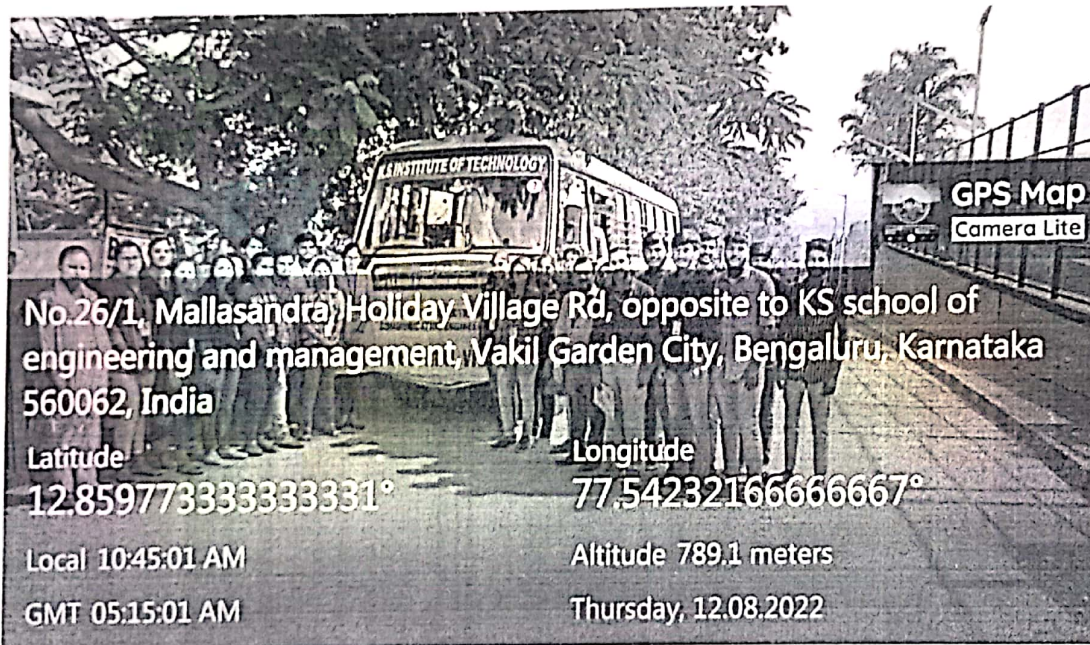


Fig 1: Group photo which was taken before Industrial visit at KSSEM Campus

On 8th December 2022, 47 Electronics and Communication Engineering 5th semester students along with the faculty Mr. Dileep J and Mrs. Vijayalaxmi, Assistant Professor, went on an industrial visit to Divya Enterprises located at vasanthapura main road, subramanyapura post, Bengaluru.

### **Company profile:**

Divya Enterprises provides high quality wiring harness and connector assemblies to industries using best of machinery, process and automation. The blend of excellent manpower and the technology employed translates into a perfect solution for their clients needs, that is unmatched in the industry. The right resources are optimized to create the best solution at very competitive pricing.

### **Aim of industrial visit:**

The main aim of industrial visit is to provide students with an opportunity to learn practically through interaction, working methods and employment practices. It also provides good opportunity to learn about the latest technology. It provides a platform for students to enhance their knowledge while familiarizing with various tools and equipment's.

### **Objectives:**

1. Get awareness of industry and their productions.
2. Understand different applications of cable connectors.
3. To know the assembling process of cable connectors.
4. To understand the market demand of these products.

In this industrial visit, students came across machines used for wiring harness and for connector assembling like:

- Automatic cutting, stripping and crimping machine (fully automatic machine for single sided crimping process)
- Automatic wire cutting machines (this can cut round cables or single core cables upto 4mm outer diameter for a specified length)
- Automatic crimping machines (versatile and powerful bench top gear driven crimping press)
- Automatic sleeve cutting machine
- Automatic multi core wire stripping machine
- Crimp force analyzer
- Pull force tester





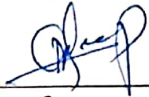

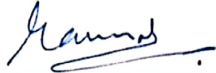

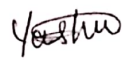
Fig 2: Interaction with students by Expert in front of Machine and Equipment

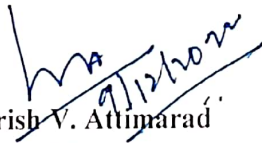



Fig 3: Group photo which was taken after Industrial visit at Divya Enterprises

The visit was concluded with a question - answer session. Students were interacted with industry experts and asked many queries regarding Entrepreneurship and small scale industries. The visit came to end at 12:45PM. Everyone reached at KSSEM campus at 1.15PM on the same day. It was an informative, interesting and successful visit.

Report Submitted By

Name	Designation	Signature
Mr. Dileep J	Assistant Professor	
Mrs. Vijayalaxmi	Assistant Professor	
Dr. Manu D K	Industrial Visit Coordinator	
Mrs. Uma C	5 <sup>th</sup> sem student	
Mrs. Yashaswini	5 <sup>th</sup> sem student	

  
 Dr. Girish V. Attimarad  
 HOD  
 Dept. of ECE  
 Professor & Head  
 Dept. of Electronics & Communication Engineering,  
 K. S. School of Engineering & Management  
 Bangalore-560 109

  
 Dr. K. Ramanarasimha  
 Principal  
 K.S.S.E.M  
 Dr. K. RAMANARASIMHA  
 Principal/Director  
 K S School of Engineering and Management  
 Bengaluru - 560 109





**KSSEM**

KammavariSangham (R) 1952

K. S. GROUP OF INSTITUTIONS

**K. S. SCHOOL OF ENGINEERING AND MANAGEMENT**

Approved by AICTE, New Delhi; Affiliated to VTU, Belagavi, Karnataka; Accredited by NAAC

www.kssem.edu.in

**DEPARTMENT OF ELECTRONICS AND COMMUNICATION ENGINEERING**

### Demo on

### Moku Go, An innovative Product for Engineers and Students

Department of Electronics and Communication Engineering organized a demo on Moku Go product to faculties of ECE department on 8<sup>th</sup> November 2022 at 2PM in HDL Lab.

Moku Go is a complete lab solution for engineers and students to actively test designs and projects. Featuring 11 instruments, full range of connectivity and optional programmable power supplies, Moku Go can do work anywhere eliminating the need for bulky bench top equipment.

Dr Girish V Attimarad, HOD, Dept of ECE, KSSEM and all the faculties of ECE department were present for the demo. Mr Mahaveer R Savanur and Mr J Sridhar addressed them and gave a brief demo on the product also about the specifications of the product.

#### Moku Go Specifications

- 1) Programmable Power Supplies
  - + Or - 5V at 150mA
  - 0 to 16V at 150mA
- 2) 4 Channel option
  - + Or - 5V at 150mA
  - 0 to 16V at 150mA
  - Dual 0.6V to 5V at 1A
- 3) Analog inputs
  - 2 x 12bit, 125MSa/s input channels
  - 30MHz analog bandwidth
- 4) Analog outputs
  - 2 x 12bit, 125MSa/s output channels
  - 20MHz analog bandwidth
- 5) Digital I/O
  - 16-Channel DIO at 62.5MSa/s



**KSSEM**  
K. S. SCHOOL OF ENGINEERING AND MANAGEMENT

KammavariSangham (R) 1952

K. S. GROUP OF INSTITUTIONS

**K. S. SCHOOL OF ENGINEERING AND MANAGEMENT**  
Approved by AICTE, New Delhi; Affiliated to VTU, Belagavi, Karnataka; Accredited by NAAC

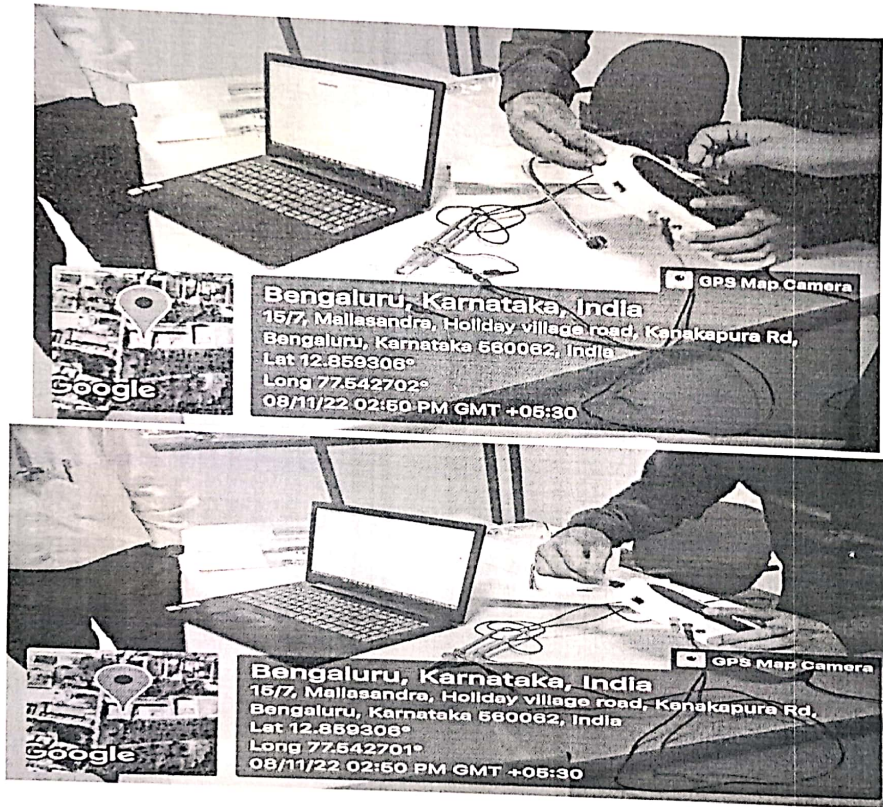
www.ksem.edu.in

**DEPARTMENT OF ELECTRONICS AND COMMUNICATION ENGINEERING**



Fig: Moku Go

Photo Gallery:







**KSSEM**  
K. S. SCHOOL OF ENGINEERING AND MANAGEMENT

KammavariSangham (R) 1952

K. S. GROUP OF INSTITUTIONS

**K. S. SCHOOL OF ENGINEERING AND MANAGEMENT**  
Approved by AICTE, New Delhi; Affiliated to VTU, Belagavi, Karnataka; Accredited by NAAC

www.kssem.edu.in

**DEPARTMENT OF ELECTRONICS AND COMMUNICATION ENGINEERING**



*hm*  
Signature of HOD, ECE

Professor & Head  
Dept. of Electronics & Communication Engineering  
K. S. School of Engineering & Management  
Bangalore-560 109





**KSSEM**  
K. S. SCHOOL OF ENGINEERING AND MANAGEMENT

Kammavari Sangham (R) 1952

K. S. GROUP OF INSTITUTIONS

**K. S. SCHOOL OF ENGINEERING AND MANAGEMENT**

Approved by AICTE, New Delhi; Affiliated to VTU, Belagavi, Karnataka; Accredited by NAAC

www.kssem.edu.in

**DEPARTMENT OF ELECTRONICS AND COMMUNICATION ENGINEERING**

**K S School of Engineering & Management, Bengaluru-560 109**

**Department of Electronics & Communication Engineering**

**Organizes One Hour Informative Talk on**

**Mutual Funds**

**Corporate Fixed Deposits**

**Government of India Bonds**

**Public Issues- Equity IPOs**

**Health Insurances**

**By**

**Mr. Naveen Kumar**

**Regional Manager, BLUECHIP Corporate Investment Centre Pvt. Ltd. Mumbai.**

**Date: 18/1/2023, Wednesday, Time: 11:30am**

**Venue: Aryabhata Seminar Hall**

**All are Cordially Invited**

**Dr. Girish V Attimarad**

**HOD, ECE dept, KSSEM**

**Dr. K. Ramanarasimha**

**Principal/Director, KSSEM**







**KSSEM**

KammavariSangham (R) 1952

K. S. GROUP OF INSTITUTIONS

**K. S. SCHOOL OF ENGINEERING AND MANAGEMENT**

Approved by AICTE, New Delhi; Affiliated to VTU, Belagavi, Karnataka; Accredited by NAAC

www.kssem.edu.in

**DEPARTMENT OF ELECTRONICS AND COMMUNICATION ENGINEERING**

### Report on

### Informative Talk on Investments

Department of Electronics and Communication Engineering organized an informative talk on investments to the faculties of all departments, on 18/01/2023 at 11:30 AM in Aryabhata seminar hall. The speaker Mr. Naveen Kumar explained that mutual fund is a professionally managed investment fund that pools money from many investors to purchase securities.

Mutual funds are often classified by their principal investments: money market funds, bond or fixed income funds, stock or equity funds, or hybrid funds. Funds may also be categorized as index funds, which are passively managed funds that track the performance of an index, such as a stock market index or bond market index, or actively managed funds, which seek to outperform stock market indices but generally charge higher fees. Primary structures of mutual funds are open-end funds, closed-end funds, unit investment trusts.

#### Photo Gallery:

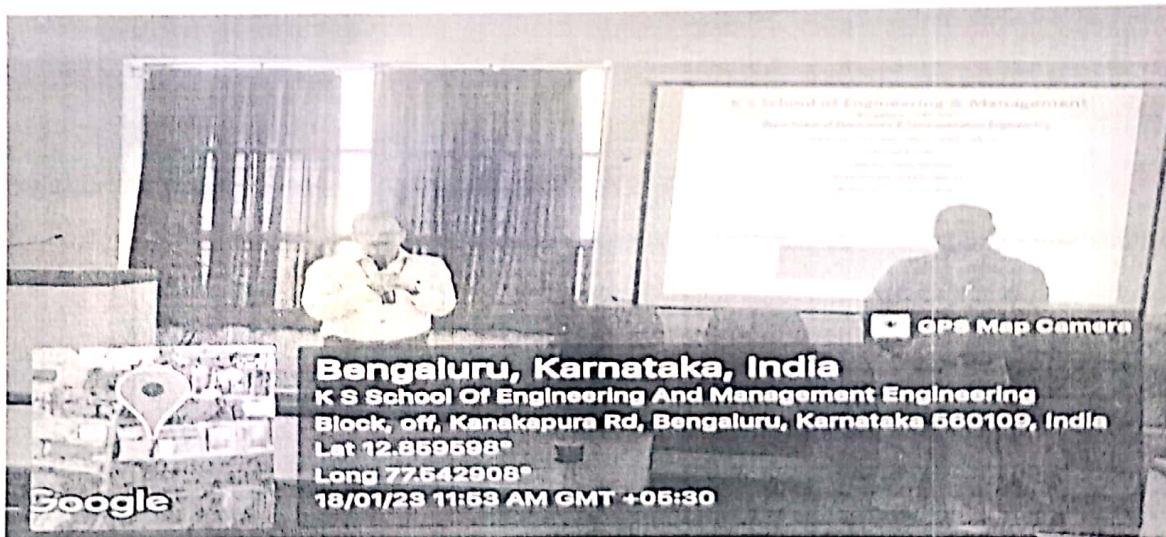


Fig: Explanation about mutual funds by the speaker



KammavariSangham (R) 1952  
K. S. GROUP OF INSTITUTIONS

**K. S. SCHOOL OF ENGINEERING AND MANAGEMENT**  
Approved by AICTE, New Delhi; Affiliated to VTU, Belagavi, Karnataka; Accredited by NAAC

www.kssem.edu.in

**KSSEM**

**DEPARTMENT OF ELECTRONICS AND COMMUNICATION ENGINEERING**



Fig: HoDs and Faculties of various departments

*[Handwritten Signature]*  
28/1/23

Signature of HOD, ECE

Professor & Head  
Dept. of Electronics & Communication Engineering  
K. S. School of Engineering & Management  
Bangalore-560 109





Attendance for field visit to Art of Living International Centre, Bengaluru on 28/02/2023

K.S. SCHOOL OF ENGINEERING AND MANAGEMENT, BENGALURU-560 109

Branch : Electronics and Communication Engineering

Academic Year : 2022-23

Semester : 3 B

Sl. No.	USN	Name of the Student	Morning	Afternoon	
1	1KG21EC055	NANDAN KUMAR V S	✓	✓	P
2	1KG21EC056	NAVEEN KUMAR K	✓	✓	P
3	1KG21EC057	NIKHIL P N	✓	✓	P
4	1KG21EC058	NITHIN B	✓	✓	A
5	1KG21EC059	NITHIN KUMAR N	✓	✓	P
6	1KG21EC060	PATHAKAMURI BALA CHANDRA	✓	✓	A
7	1KG21EC061	PAVAN K N	✓	✓	P
8	1KG21EC062	PAVAN M D	✓	✓	P
9	1KG21EC063	PAVAN S	✓	✓	P
10	1KG21EC064	PRAMOD S	✓	✓	P
11	1KG21EC065	PRATAPANENI YOGESH	✓	✓	P
12	1KG21EC066	PUNITH P	✓	✓	P
13	1KG21EC067	R DAXIN	✓	✓	P
14	1KG21EC068	R M LAVYA	✓	✓	P
15	1KG21EC069	RAGAVENDRA NAIDU A R	✓	✓	A
16	1KG21EC070	RAKSHITHA H	✓	✓	P
17	1KG21EC071	RAM PRASAD P V	✓	✓	P
18	1KG21EC072	RAYAVARAM ABHINASH	✓	✓	A
19	1KG21EC073	ROHITH M J	✓	✓	P
20	1KG21EC074	SAHANA S	✓	✓	P
21	1KG21EC075	SAI CHOWDARY L	✓	✓	P
22	1KG21EC076	SAI LOKESH C S	✓	✓	P
23	1KG21EC077	SAI MEGHANA K M	✓	✓	P
24	1KG21EC078	SANDI REDDY ABHINAY	✓	✓	P
25	1KG21EC079	SANJANA P	✓	✓	P
26	1KG21EC080	SARIPUTI CHENNAKESAVA NAIDU	✓	✓	P
27	1KG21EC081	SATHVIK A N	✓	✓	P
28	1KG21EC082	SHASHANK B VENKATESH	✓	✓	P
29	1KG21EC083	SHASHANK G NAYAK	✓	✓	P
30	1KG21EC084	SHASHANK S	✓	✓	P
31	1KG21EC085	SHIJU LUKOSE	✓	✓	A
32	1KG21EC086	SHREYA M DAMBAL	✓	✓	P
33	1KG21EC087	SIMRAN TAJ B	✓	✓	P
34	1KG21EC088	SONISH K R	✓	✓	P
35	1KG21EC089	SONU N	✓	✓	P
36	1KG21EC090	SPOORTHI V	✓	✓	P
37	1KG21EC091	SRUJAN R	✓	✓	P
38	1KG21EC092	SUDHEERSHANA K V	✓	✓	P
39	1KG21EC094	T VENKATESH	✓	✓	A
40	1KG21EC095	TEJAS K	✓	✓	P
41	1KG21EC096	THANUSHA R	✓	✓	P
42	1KG21EC097	THARUN KUMAR D R	✓	✓	P
43	1KG21EC098	THEERTHA RAJ G	✓	✓	P
44	1KG21EC099	V NIKHIL	✓	✓	P
45	1KG21EC100	VANDANA PRAKASH	✓	✓	P
46	1KG21EC101	VIDYA SAGAR B K	✓	✓	P
47	1KG21EC102	VIKAS H J	✓	✓	A
48	1KG21EC103	VRISHALI R	✓	✓	P
49	1KG21EC104	Y LAHARI	✓	✓	P
50	1KG21EC105	Y SUPRITH	✓	✓	P
51	1KG21EC106	YASWANTH PADAPATI	✓	✓	P
52	1KG21EC107	YUGANDHAR P	✓	✓	P
53		C SRAVANI	✓	✓	P
54		CHEZHAN SHANKARGOUDA EGANGOUDAR	✓	✓	P
55		Ajith	✓	✓	P
56		Shashank R	✓	✓	P
57		CHANDRASEKAR B	✓	✓	A
58		K UDAY KIRAN	✓	✓	P
59		MEGHA S KANKANAMELI	✓	✓	P
60		SAGAR K A	✓	✓	P
61		SHARATH KUMAR G B	✓	✓	P
62		Madan Gowda	✓	✓	P

	Total students	Present student	Absent student
3A	60	54	06
3B	62	54	08
Total	122	108	14
	staff	05	
		<u>113</u>	



Sl. No.	USN	Name of the Student	Morning	Afternoon	
1	1KG21EC001	A VENISHA CHOWDARY	✓	✓	P
2	1KG21EC002	ABHINANDAN A	✓	✓	A
3	1KG21EC003	AJAY N V	✓	✓	P
4	1KG21EC004	AKSHITHA URS M C	✓	✓	P
5	1KG21EC005	AMILINENI YASWANTH	✓	✓	P
6	1KG21EC006	ANANYA B SHETTY	✓	✓	P
7	1KG21EC008	ANANYA N	✓	✓	P
8	1KG21EC009	ANAVULAMUDI HARIKRISHNA CHOWDARY	✓	✓	P
9	1KG21EC010	ANIKA KAVYA TIPPINNI	✓	✓	P
10	1KG21EC011	ASHOK J SUTHAR	✓	✓	A
11	1KG21EC012	BANAPURAM UDAY KIRAN	✓	✓	P
12	1KG21EC013	BHARGAV R RAO	✓	✓	A
13	1KG21EC015	BHUMIKA B R	✓	✓	P
14	1KG21EC016	BODAPATI MARUTHI CHOWDARY	✓	✓	P
15	1KG21EC017	CHALLA NITHIN	✓	✓	A
16	1KG21EC018	CHANDAN YADAV S	✓	✓	P
17	1KG21EC019	DARAPANENI ABHINAY CHOWDARY	✓	✓	P
18	1KG21EC020	DARSHINI R	✓	✓	P
19	1KG21EC021	DEVIKA T S	✓	✓	P
20	1KG21EC022	DHANUSH B	✓	✓	P
21	1KG21EC023	DILKUSH VISHNOI	✓	✓	P
22	1KG21EC024	G MAHITHA	✓	✓	P
23	1KG21EC025	G S TEJAS	✓	✓	P
24	1KG21EC026	G USHA SHREE	✓	✓	P
25	1KG21EC027	GANESH R	✓	✓	P
26	1KG21EC028	GARLAPATI YUVA TEJA NAIDU	✓	✓	P
27	1KG21EC029	GONGUNTLA PAVAN KUMAR	✓	✓	P
28	1KG21EC030	HARSHINI A	✓	✓	P
29	1KG21EC031	HARSHITHA R DAS	✓	✓	P
30	1KG21EC032	HARSHITHA U	✓	✓	P
31	1KG21EC033	JEEVAN A A	✓	✓	P
32	1KG21EC034	JOSHWA A	✓	✓	P
33	1KG21EC035	JYOTHISH K	✓	✓	P
34	1KG21EC036	K ATAPPA GARI JEEVAN SAI REDDY	✓	✓	P
35	1KG21EC038	KORRAKUTI SAI CHENNA KESAVA NAIDU	✓	✓	P
36	1KG21EC039	LATHA P N	✓	✓	P
37	1KG21EC040	LAVANYASHREE T N	✓	✓	P
38	1KG21EC041	LIKITH N	✓	✓	P
39	1KG21EC042	M PRASHANTH KUMAR	✓	✓	P
40	1KG21EC043	MAHESH K	✓	✓	P
41	1KG21EC044	MALLEMPUTA LAKSHMI	✓	✓	A
42	1KG21EC045	MANISH S	✓	✓	P
43	1KG21EC046	MANOJ P K	✓	✓	P
44	1KG21EC047	MANOJ S	✓	✓	P
45	1KG21EC048	MANSI MANJUNATH LOKHANDAY	✓	✓	P
46	1KG21EC049	MELLAMPUTI ABHILASH	✓	✓	P
47	1KG21EC050	MODIPALLI HARIKA	✓	✓	A
48	1KG21EC051	MOHAMMED ZAID F	✓	✓	P
49	1KG21EC052	MUTHINENI LIKITHA	✓	✓	P
50	1KG21EC053	MUTHU BHARATH	✓	✓	P
51	1KG21EC054	NAGARAJ CHANDRAKANT VAGGA	✓	✓	P
52		MALLESH N	✓	✓	P
53		YENUGANTI NITHEESH KUMAR	✓	✓	P
54		DARSHINI T S	✓	✓	P
55		K VANAJA	✓	✓	P
56		Kruthik Achar R	✓	✓	P
57		karthik C M	✓	✓	P
58		SHIVA SHANKAR N	✓	✓	P
59		ANURAAG G V	✓	✓	P
60		MOHAMMED AYMAAN	✓	✓	P

DATE: 27/02/2023

To,

The Transport Incharge,  
K S S E M  
Bangalore - 560062.  
Through

HOD

Department of Electronics & Communication Engineering

Respected Sir,

Sub: Transport arrangement for the Field - visit to "Art of Living International Centre"

With reference to the above, I am hereby requesting for the transport arrangement for Student / Parent / Faculty / AIEEE / Comed-K / Cultural-Fest / Special-Class / FDP-Program / Industrial Visit / Trip / Guest Pick-&Drop / GET-Cell / Stationary-Purchasing / Stationary-from-regional-office / Railway-exam / VTU theory-exam / Valuation / LIC, AICTE & NBA-Inspection / Hospital / Metro / Malleshwaram / Mejestic /

Kindly do the need full.

DATE	VENUE DETAILS	PICKUP TIMING	DROP TIMING
28/02/2023	Art of Living International Centre	9:30 am	2:30 pm

Thanking you

Yours faithfully

Rajal  
Staff (Vijayalaxmi C. K)

[Signature]  
HOD

[Signature]  
Principal/Director  
27/2/23

[Signature]  
Transport Incharge



Date: 28/01/2023

From,

Vijayalaxmi C. Kalal,  
Assistant Professor,  
ECE Department,  
KSSEM, Bengaluru

To,

The Principal,  
K S School of Engineering and Management,  
Bengaluru

Through,

The HOD,  
ECE Department,  
KSSEM, Bengaluru

Dear Sir,

**Subject:** Regarding permission to visit Sri Sri Ravishankar Ashram, Kanakapura Road, Bengaluru.

As per the curriculum of 3<sup>rd</sup> semester BE- Electronics and Communication Engineering for the subject **Social Connect and Responsibility (21SCR36)**, the students should visit, learn & understand the practices followed in the below mentioned areas and also the students should be made aware of the problems faced during the process.

The areas are:

1. **Organic Farming**

- What is organic farming?
- Importance/need of organic farming?
- How organic farming is practiced?
- Advantages and disadvantages of organic farming?
- Problems faced in organic farming?


2. **Wet waste Management**

- What is wet waste?
- How wet waste is managed?
- How can students do wet waste management at their home/college/surroundings?

Please allow us to visit the ashram for one day from the following dates:- 13/02/2023 to 17/02/2023. Total of about **140 students** including staff will visit the ashram.

Thanking you,

Yours faithfully,

  
(Vijayalaxmi C. Kalal)

*Permitted*  
*K.S. Rama*  
Dr. K. RAMA NARASIMHA  
Principal/Director  
K S School of Engineering and Management  
Bengaluru - 560 109

*28/1/23*  
*hmr*  
*28/1/23*  
Professor & Head  
Dept. of Electronics & Communication Engineering  
K. S. School of Engineering & Management  
Bangalore-560 109





**KSSEM**  
K. S. SCHOOL OF ENGINEERING AND MANAGEMENT

KammavariSangham (R) 1952

K. S. GROUP OF INSTITUTIONS

**K. S. SCHOOL OF ENGINEERING AND MANAGEMENT**  
Approved by AICTE, New Delhi; Affiliated to VTU, Belagavi, Karnataka; Accredited by NAAC

www.kssem.edu.in

**DEPARTMENT OF ELECTRONICS AND COMMUNICATION ENGINEERING**

## Report on

### Field Visit to Art of Living International Center, Bengaluru

The Department of Electronics and Communication Engineering organized a Field Visit to the Art of Living International Centre, Ved Vignan Maha VidyaPeeth, 21<sup>st</sup> km, Kanakapura Road, Udayapura, Bengaluru, Karnataka-560 082, for the 3<sup>rd</sup> Semester ECE students on 28<sup>th</sup> February 2023.

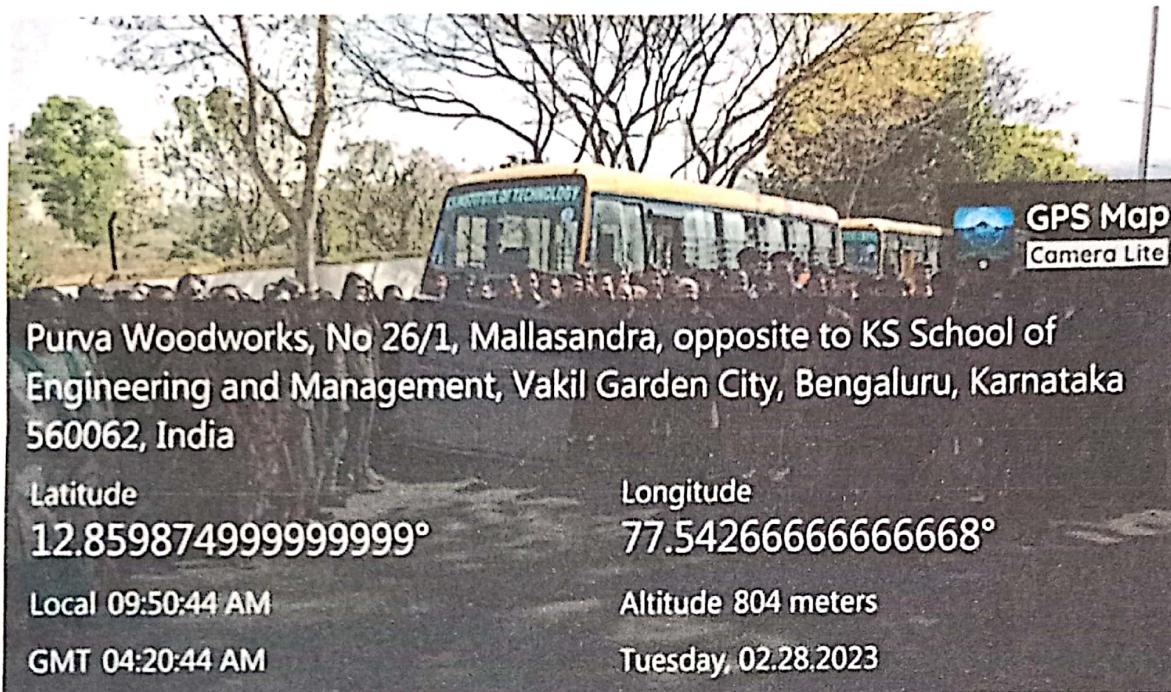


Fig 1: Group photo taken at KSSEM campus, before leaving for the visit to Art of Living International Center

In accordance with the curriculum of 3<sup>rd</sup> semester course on “Social Connect and Responsibility” (21SCR36), the visit was organized to observe and educate the students regarding the work done by the ashram in areas including Wet Waste Management, Rainwater Harvesting and Organic Farming, along with social welfare initiatives.

The faculty members Mrs. Vijayalaxmi C. Kalal, Assistant Professor, Mr. Ravikiran B A, Assistant Professor, Mrs. Hemapriya M, Assistant Professor, Mr. Anilkumar G P, Instructor and Mr. Satish, Attender accompanied the students during the visit.

The ashram is located on the outskirts of Bengaluru. It is spread over three hundred acres of land. As soon as we entered the ashram the volunteers guided us through the ashram.







**KSSEM**  
K. S. SCHOOL OF ENGINEERING AND MANAGEMENT

KammavariSangham (R) 1952

**K. S. GROUP OF INSTITUTIONS**

**K. S. SCHOOL OF ENGINEERING AND MANAGEMENT**

Approved by AICTE, New Delhi; Affiliated to VTU, Belagavi, Karnataka; Accredited by NAAC

www.kssem.edu.in

**DEPARTMENT OF ELECTRONICS AND COMMUNICATION ENGINEERING**

During the field visit the students visited the following sections of the Ashram:

- Sri Sri Gaushala
- Art of Living Permaculture Farm
- Sri Sri Gurukul
- Vishalakshi Mantap
- Annapoorna Hal I- the Art of Living's Community Kitchen

### Sri Sri Gaushala

The Sri Sri Gaushala has been set up at the ashram, in order to preserve and protect indigenous cows. This initiative aims to preserve and educate the visitors regarding the various indigenous breeds of cattle including Gir, Sahiwal, Ongole, Kangayam, Tharparkar, Kasargida, Kankrej, Dangi, Alambadi, Hallikar, Rathi, Pulikulam, Umbalacheri, & Punganur breeds. The Gaushala hosts a total of 800+ cows, belonging to 15 Indian breeds. The five products obtained from the cows i.e., milk, curd, ghee, urine, & cow dung are used in medicine, pesticide, manure & for various other household remedies. Fixed meals of fresh and dry fodder, gram husk, and mineral supplements are served to them in their sheds, twice a day. They are let out mid-morning for grazing. The cows are milked twice a day and the milk is distributed in the ashram. Production of biogas (methane) and manure from cow dung is done for meeting the energy and manure needs at the ashram.



**Fig 2: Sri Sri Gaushala's Desi Cows**





**KSSEM**  
K. S. GROUP OF INSTITUTIONS

KammavariSangham (R) 1952

**K. S. GROUP OF INSTITUTIONS**

**K. S. SCHOOL OF ENGINEERING AND MANAGEMENT**

Approved by AICTE, New Delhi; Affiliated to VTU, Belagavi, Karnataka; Accredited by NAAC

www.kssem.edu.in

**DEPARTMENT OF ELECTRONICS AND COMMUNICATION ENGINEERING**

The biodegradable farm waste and kitchen waste is turned into a compost to produce compost, which is used as fertilizer. The compost bins are layered with wet waste as well as dry waste, and over a period of weeks, compost is produced. The compost bins also act as starter bins for initial growth of small plants and microgreens, which are later transplanted to the ground.



Fig: Compost bins at the Permaculture farm

### Sri Sri Gurukula

The Veda Agama Samskrutha Maha Patashala is an initiative by the Art of Living, which aims to impart Vedic education to underprivileged students from all over the country. The Pathasala was started in October 2002. Here, the students come from all over the country to learn the Dravidian styles as well as all aspects of learning related to temple worship with general education. The students from underprivileged backgrounds are provided free residential facilities, food and education in the Vedic traditions and rituals. The Art of Living also provides free education to students from economically weaker sections all over the country.



Fig 3: Panchmukhi Ganesha Temple







**KSSEM**  
K. S. GROUP OF INSTITUTIONS

KammavariSangham (R) 1952

K. S. GROUP OF INSTITUTIONS

**K. S. SCHOOL OF ENGINEERING AND MANAGEMENT**

Approved by AICTE, New Delhi; Affiliated to VTU, Belagavi, Karnataka; Accredited by NAAC

www.kssem.edu.in

**DEPARTMENT OF ELECTRONICS AND COMMUNICATION ENGINEERING**

### Annapoorna Hall - the Art of Living's Community Kitchen

The Art of Living's Annapoorna Hall is their Community Kitchen. It serves around 23,000 meals a day to thousands of people from across the world. People from diverse cultures, borders, and backgrounds sit together, and eat in the huge dining area, with a feeling of oneness. The food grown in the permaculture farms is cooked, and the food is distributed for free to the visitors and staff in the Ashram.

The visit was a very educational experience, where the students learned about various initiatives that can be employed towards social welfare practices, environmental protection and sustainable farming.

The students learned about the individual's role and responsibility towards protecting our environment and get nutrient rich food for us, our family, for the welfare of human and animals. The Ashram is an institution which gives importance to the traditional way of farming, meditation to lead a stress-free life, a place where abounded animals are taken care, and it creates awareness to public by conducting various training sessions.

Event Coordinator: Mrs Vijayalaxmi C Kalal - *Kalal*  
Staff Coordinator : Mr Ravikiran B A *BANE*  
Mrs. Hemapriya M *Priya*

*K. Rama*  
HOD, ECE

Professor & Head  
Dept. of Electronics & Communication Engineering  
K. S. School of Engineering & Management  
Bengaluru - 560 109

*K. Rama*  
PRINCIPAL

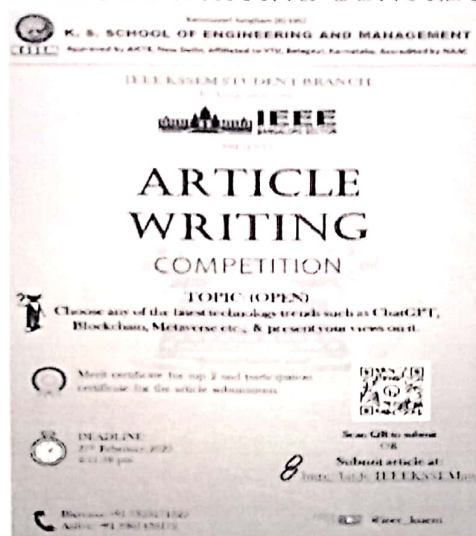
Dr. K. RAMA NARASIMHA  
Principal/Director  
K S School of Engineering and Management  
Bengaluru - 560 109





Kammavari Sangham (R) 1952  
K. S. GROUP OF INSTITUTIONS  
**K. S. SCHOOL OF ENGINEERING AND MANAGEMENT**  
Approved by AICTE, New Delhi; Affiliated to VTU, Belagavi, Karnataka; Accredited by NAAC  
www.kssem.edu.in  
**DEPARTMENT OF ELECTRONICS AND COMMUNICATION ENGINEERING**

**REPORT**  
ON  
**ARTICLE WRITING CONTEST**



**Event name:** 'ARTICLE WRITING' contest

**Date of event:** 27th February , 2023

**Venue:** Online mode

**Targeted Audience:** Students of all colleges.

The IEEE KSSEM Student branch in association with the ECE department of KSSEM, had organized a 'ARTICLE WRITING' contest on 27<sup>th</sup> February, 2023 through online mode which was an inter college competition.

The topic for the contest was open to the participants, so that they can choose their own topic and present their clear view on that chosen topic. Also suggested to choose the latest trends in Technology. The major topics that were chosen are ChatGPT, Metaverse, blockchain, VR & AR, and so on., from students of different colleges. The articles contained background and brief descriptions of a particular technology. How does that work? Types in that technology, comparison between the chosen Technologies with the other.





Kammavari Sangham (R) 1952  
K. S. GROUP OF INSTITUTIONS

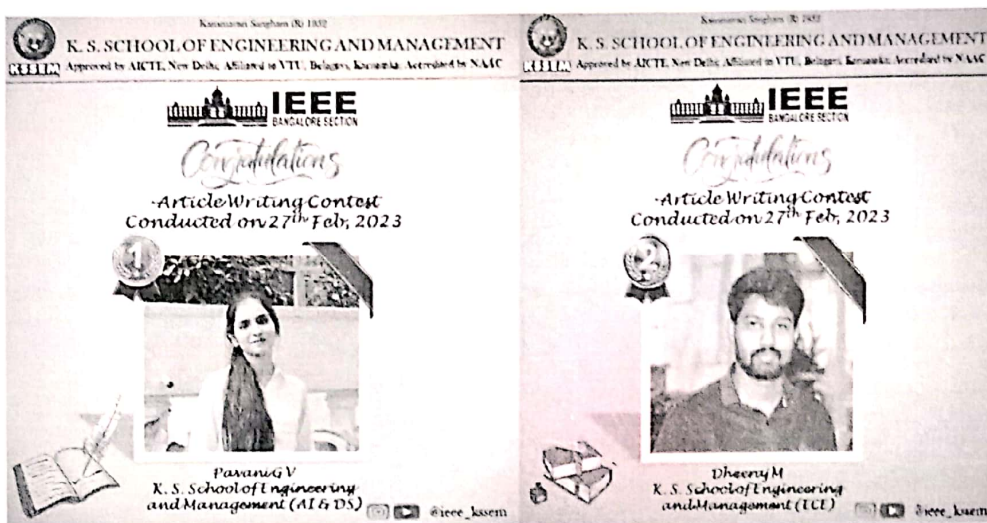
**K. S. SCHOOL OF ENGINEERING AND MANAGEMENT**  
Approved by AICTE, New Delhi; Affiliated to VTU, Belagavi, Karnataka; Accredited by NAAC  
www.kssem.edu.in



**DEPARTMENT OF ELECTRONICS AND COMMUNICATION ENGINEERING**

The articles also contained benefits, drawbacks and also the ideas to get best of that technology. The participants have consolidated their ideas rather than and presented effectively. They have also structured their thoughts within the word limits.

The evaluation of this article writing competition was done based on relevancy, clarity, and productivity. The evaluators have taken much care in identifying the two best articles out of all the articles received.



Event Coordinator: Dr Karthik P

HoD

Professor & Head  
Dept. of Electronics & Co-communication Engineering  
K. S. School of Engineering & Management  
Bangalore



KammavariSangham (R) 1952  
K. S. GROUP OF INSTITUTIONS

**K. S. SCHOOL OF ENGINEERING AND MANAGEMENT**  
Approved by AICTE, New Delhi; Affiliated to VTU, Belagavi, Karnataka; Accredited by NAAC  
www.kssem.edu.in

**DEPARTMENT OF ELECTRONICS AND COMMUNICATION ENGINEERING**

## Report on

# Campus to Corporate Journey



Organized by IEEE Student Branch, KSSEM

In association with IEEE Bangalore section.

Event name: Seminar

Topic: Campus to Corporate journey

Date of event: 08<sup>th</sup> March, 2023

Venue: Aryabhata Seminar Hall, Dept of ECE, KSSEM

Number of participants: 60

Targeted Audience: 1<sup>st</sup> year ECE students

The IEEE Student branch in association with the ECE department, of KSSEM, had organized a seminar on, "Campus to Corporate Journey" on 08<sup>th</sup> March, 2023 at 10:00am IST.

The seminar was conducted at K.S School of Engineering & Management, Bangalore. The talk was delivered by Ms. MK Priya, Senior Software Engineer at Ericsson R&D. Dr.K Senthil Babu, HoD of ECE, graced the event with his presence. The seminar was attended by both — faculty members and students.

The objective of the seminar was to prepare the students who are about to enter the corporate world by providing them with an understanding of the transition process from campus to corporate.







**KSSEM**  
K. S. GROUP OF INSTITUTIONS

KammavariSangham (R) 1952

K. S. GROUP OF INSTITUTIONS

**K. S. SCHOOL OF ENGINEERING AND MANAGEMENT**

Approved by AICTE, New Delhi; Affiliated to VTU, Belagavi, Karnataka; Accredited by NAAC

www.kssem.edu.in

**DEPARTMENT OF ELECTRONICS AND COMMUNICATION ENGINEERING**

### Topics Covered:

The seminar covered various aspects of the transition process from campus to corporate. Some of the topics discussed were:

- Expectations and Realities of Corporate Life
- Professionalism and Work Ethics
- Communication Skills
- Time Management
- Emotional Intelligence
- Corporate Culture
- Career Growth and Development

### Key Takeaways:

- It is essential to set realistic expectations about the corporate world and be prepared for the challenges that come with it.
- Professionalism and work ethics are crucial for success in the corporate world.
- Communication skills play a vital role in building relationships and networking in the corporate world.
- Time management is crucial for meeting deadlines and achieving goals.
- Emotional intelligence is essential for effective communication and teamwork.
- Understanding and adapting to the corporate culture is crucial for success.
- Continuous learning and career development are important for career growth and success.

### Conclusion:

In conclusion, the seminar on 'Campus to Corporate' was a success. The students gained valuable insights and knowledge about the transition process from campus to corporate. The seminar also served as an excellent platform for the students to interact with the speaker and network with their peers. The seminar was a great learning experience for everyone who attended, and we look forward to organizing more such events in the future.



KammavariSangham (R) 1952

K. S. GROUP OF INSTITUTIONS

# K. S. SCHOOL OF ENGINEERING AND MANAGEMENT

Approved by AICTE, New Delhi; Affiliated to VTU, Belagavi, Karnataka; Accredited by NAAC

www.kssem.edu.in



DEPARTMENT OF ELECTRONICS AND COMMUNICATION ENGINEERING



Fig 1. Invitation for the event




Fig 2. Participants in the Event



Fig 3. Addressing the participants by the Speaker of the day

  
Event Coordinator: Dr Karthik P

  
Signature of HoD, ECE  
Professor & Head  
of Electronics & Communication Engineering  
K. S. School of Engineering & Management  
Bangalore-560 109





**KSSEM**  
K. S. SCHOOL OF ENGINEERING AND MANAGEMENT

KammavariSangham (R) 1952

K. S. GROUP OF INSTITUTIONS

**K. S. SCHOOL OF ENGINEERING AND MANAGEMENT**

Approved by AICTE, New Delhi; Affiliated to VTU, Belagavi, Karnataka; Accredited by NAAC

www.kssem.edu.in

**DEPARTMENT OF ELECTRONICS AND COMMUNICATION ENGINEERING**

### Report on

### International Women's Day Celebration

A grand celebration was organised to celebrate International Women's Day on 8<sup>th</sup> of March 2023 in Civil Auditorium KSSEM, Bangalore at 11:30 AM by IEEE Student Branch. All the women employees working in KSSEM of various departments were invited to join the program.

On the same occasion, the guest of honour, Ms. M K Priya shared her tales of struggle and success. Further she said gender equality is very important for a healthy society. The milestone to be reached is the basic information for a girl child in every family. Education creates awareness among the society which will further result in overall development of nation and its community.

Dr. Vijayalakshmi Akella, Professor & Head, Dept. of Civil Engineering graced the occasion, and addressed the attendees. She expressed the belief that everyone should celebrate every day as women's day and acknowledged the role of men behind every successful women and vice versa. She conveyed that there should be a balance between career and family and that without family support, a women cannot achieve success.

The KSSEM IEEE Student branch organised fun activities for all the staff who participated in the events and distributed the prizes to the winners. Sweets and snacks were distributed for all the participants.

#### Photo Gallery:



Fig 1. Women's Day Celebration at Civil Auditorium.





KammavariSangham (R) 1952  
K. S. GROUP OF INSTITUTIONS

**K. S. SCHOOL OF ENGINEERING AND MANAGEMENT**  
Approved by AICTE, New Delhi; Affiliated to VTU, Belagavi, Karnataka; Accredited by NAAC  
www.kssem.edu.in



**DEPARTMENT OF ELECTRONICS AND COMMUNICATION ENGINEERING**

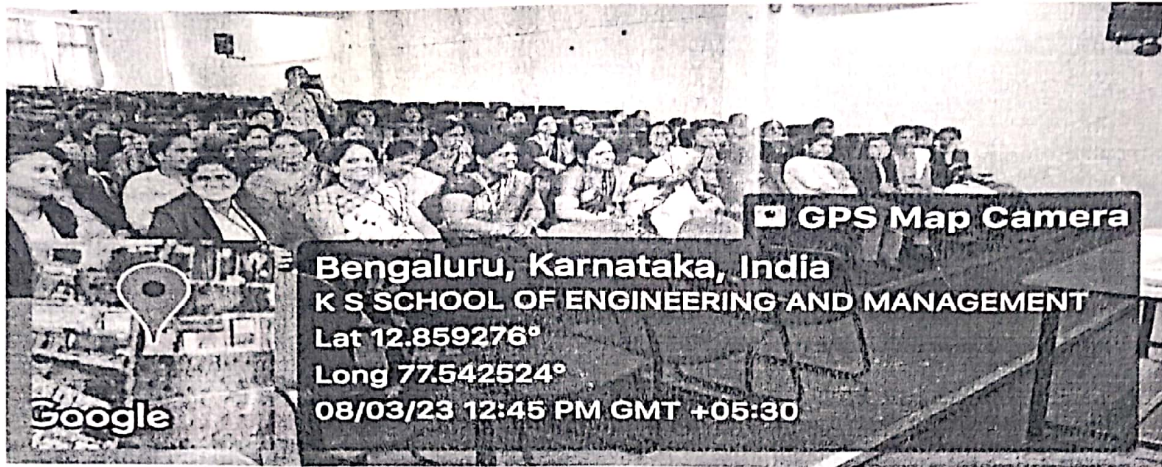


Fig 2. Participants in the Event



Fig 3. Fun activities organized by IEEE student Co-ordinators

Signature of HOD, ECE

Professor & Head  
Dept. of Electronics & Communication Engg  
K. S. School of Engineering & Management  
Bengaluru-560 109





From

IEEE KSSEM STUDENT BRANCH  
K S School of Engineering and Management,  
Bengaluru – 109  
13<sup>th</sup> February, 2023

To

The Principal  
K S School of Engineering and Management,  
Bengaluru – 109.

Respected Sir,

Subject: Request for permission and financial support to conduct Women's Day Celebrations.

We would like to celebrate the international Women's day on March 8, 2023 under the IEEE KSSEM Student Branch. In this regard we request you to give permission for organizing the same.

We kindly request you to also provide financial support for the conduction of the aforementioned program in our college.

Budget for the Event:

S.NO	Item Description	Amount in INR
1.	Honorarium	1,000/-
2.	Mementos	1,500/-
4.	Logistics and Travel Expenditure	1,000/-
5.	Activities for ladies' staff (materials)	1,500/-
6.	Cake	2,500/-
7.	Winner gifts	1,500/-
8.	Miscellaneous	1,000/-
	Total	10,000/-

Thanking You

Yours Sincerely,

*Bhavana S*

*Aafiya Kulsoom*

(Bhavana S & Aafiya Kulsoom)

*14/02/23*

*Forwarded to HOD*  
*Forwarded to principal for approval*  
*14/2/23*

Professor & Head  
Dept. of Electronics & Communication Engg.  
K S School of Engineering & Management  
Bengaluru-560 109



Kammavari Sangham (R) 1952  
K. S. GROUP OF INSTITUTIONS

**K. S. SCHOOL OF ENGINEERING AND MANAGEMENT**

Approved by AICTE, New Delhi; Affiliated to VTU, Belagavi, Karnataka; Accredited by NAAC

www.kssem.edu.in

**KSSEM**

**DEPARTMENT OF ELECTRONICS AND COMMUNICATION ENGINEERING**

---

Report on

'Technical Talk on Recent Advances in Optical Sensors in Healthcare'

Event name: Inauguration of IEEE SENSOR COUNCIL STUDENT CHAPTER

Date of event: 18 April, 2022

Targeted Audience: All students and faculty members of ECE depart.

We had an technical talk on Recent Advances in Optical Sensors in Healthcare under the IEEE Sensors Council Student Chapter, which was a new sub-branch launched in the IEEE student branch of our student branch.

The event Dr. Uttam Pal is an Assistant Professor in Biomedical Engineering Stream, Department of Sciences and Humanities, IITDM Kancheepuram-Chennai. With the recent advances in the fabrication of electronics and optical devices, we are at a horizon of developing novel in-vivo optical tools. Such tools can help understand complex biological systems, diagnose disease, and track disease progression. This talk will discuss the latest developments in optical sensors using biological tissue and fluid as interacting media. We will learn how the researchers are pushing frontiers further in the field of absorption spectroscopy; diffuse reflectance spectroscopy, polarization-sensitive spectroscopy, Raman spectroscopy, fluorescence spectroscopy, and surface plasmonic methods. The challenges of translating an optical device from bench side in laboratory to bedside in hospital settings will also be discussed.

*Attached below are a few pictures of the inauguration.*







Kammavari Sangham (R) 1952

K. S. GROUP OF INSTITUTIONS

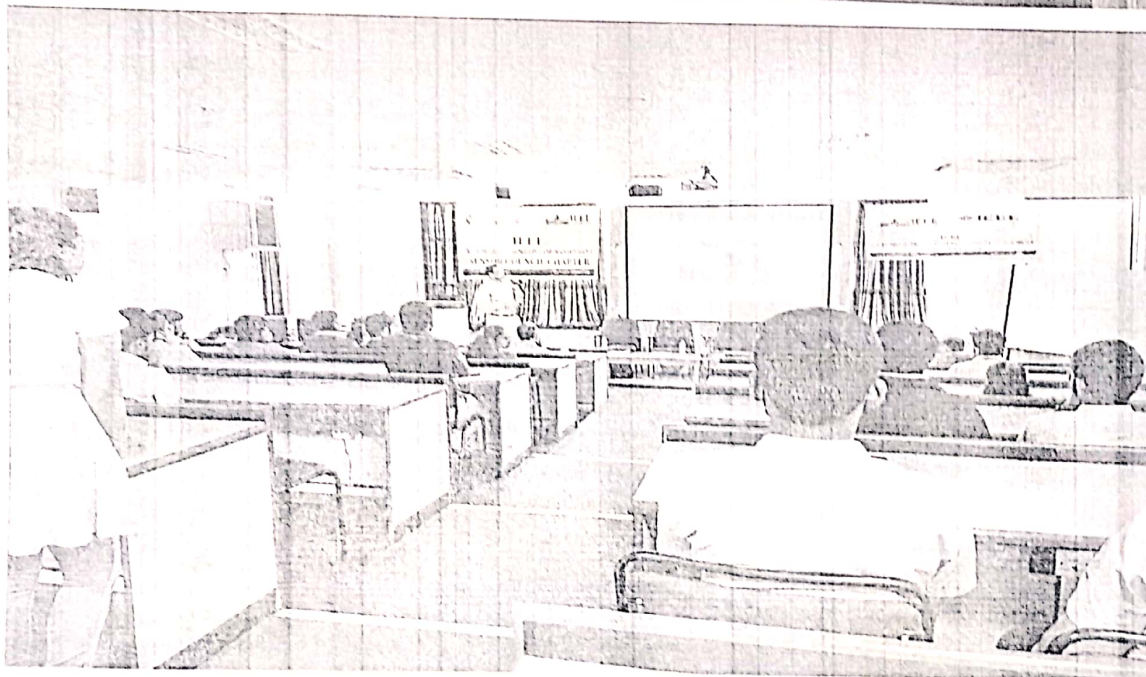
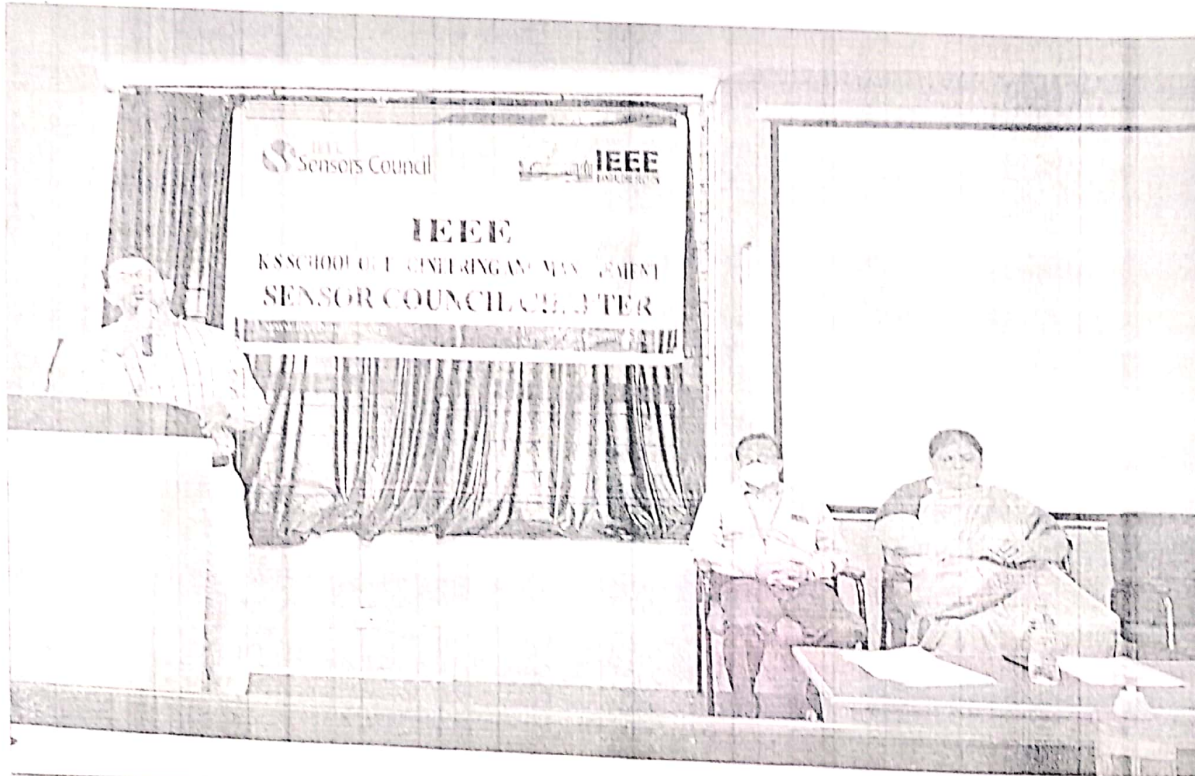
**K. S. SCHOOL OF ENGINEERING AND MANAGEMENT**

Approved by AICTE, New Delhi; Affiliated to VTU, Belagavi, Karnataka; Accredited by NAAC

[www.kssem.edu.in](http://www.kssem.edu.in)

**KSSEM**

DEPARTMENT OF ELECTRONICS AND COMMUNICATION ENGINEERING

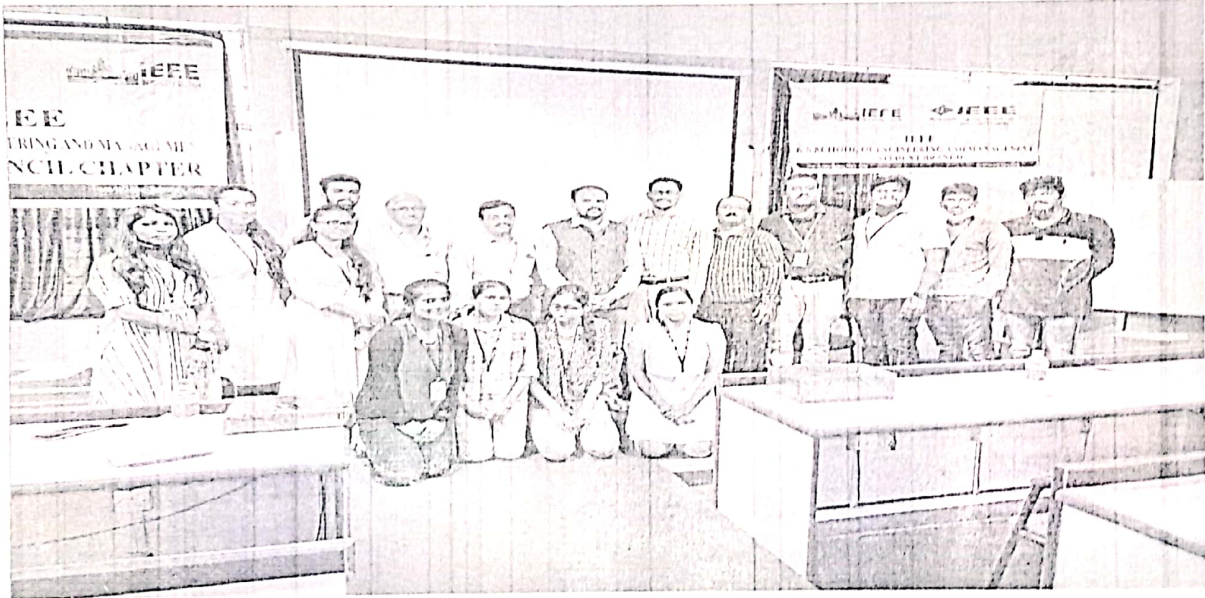




Kammavari Sangham (R) 1952  
K. S. GROUP OF INSTITUTIONS

**K. S. SCHOOL OF ENGINEERING AND MANAGEMENT**  
Approved by AICTE, New Delhi; Affiliated to VTU, Belagavi, Karnataka; Accredited by NAAC  
www.kssem.edu.in

**DEPARTMENT OF ELECTRONICS AND COMMUNICATION ENGINEERING**



*[Handwritten Signature]*  
Signature of HoD, ECE

**Professor & Head**  
Dept. of Electronics & Communication Engineering  
K. S. School of Engineering and Management  
K. S. Group of Institutions





**KSSEM**

## Technical Seminar Report on

### Wireless Communication Evolution till 5G

Event name: Technical Seminar

Topic: Wireless Communication Evolution till 5G

Date of event: 21<sup>st</sup> April, 2023

Venue: Aryabhatta Seminar Hall, Dept of ECE, KSSEM

Number of participants: 50

Targeted Audience: 3<sup>rd</sup> year ECE students

The department of Electronics and Communication Engineering, KSSEM, had organized a technical seminar on, "Wireless Communication Evolution till 5G" on 21<sup>st</sup> April, 2023 at 1:20PM IST.

The talk was delivered by Mr. Sasindran M Prabhu. Dr.K Senthil Babu, HoD of ECE, graced the event with his presence. The seminar was attended by both faculty members and students.

The objective of the technical seminar was to prepare the students about the future cellular, wifi and other wireless communication networks.

Wireless Communication is the fastest growing and most vibrant technological areas in the communication field. Wireless Communication is a method of transmitting information from one point to other, without using any connection like wires, cables or any physical medium.

Real time communication amongst the various hierarchy levels of industrial automation systems is key for efficient operation of a modern factory. It is still wired communication which is dominant in factory automation applications, in particular for stationary system components. However, with mobile robots, automated guided vehicles and other mobile devices becoming more widespread – in particular on the factory floor wireless information and command exchange approaches are increasing its market share, driven by internet of things (IoT). Campus networks whether it is Wi-Fi or 4/5/6G demand for lowest propagation delay and robust data transfer to reach real-time capability. Bluetooth for short range communication purposes entering industrial automation systems as well.



At the end of the technical seminar students were given multiple choice questions based on the session and evaluated the performance of the students.

Photo Gallery

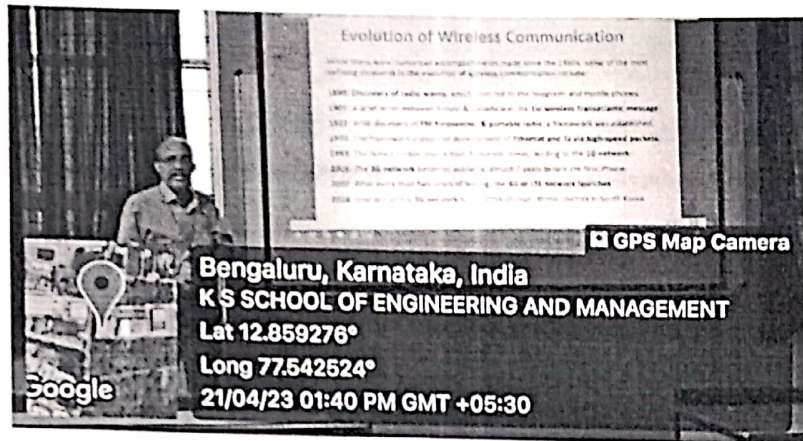


Fig 1. Speaker addressing the Audience

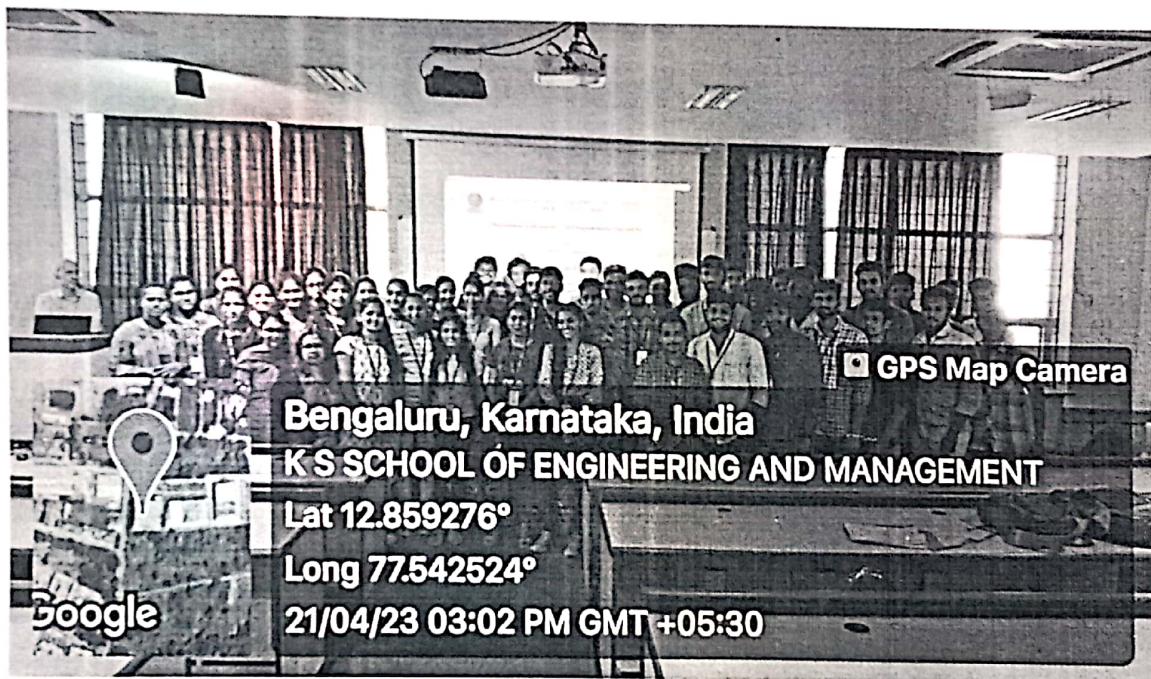


Fig 2. Students Participants in the Event





KammavariSangham (R) 1952

K. S. GROUP OF INSTITUTIONS

# K. S. SCHOOL OF ENGINEERING AND MANAGEMENT

Approved by AICTE, New Delhi; Affiliated to VTU, Belagavi, Karnataka; Accredited by NAAC

www.kssem.edu.in



DEPARTMENT OF ELECTRONICS AND COMMUNICATION ENGINEERING



Fig 3. Students and Faculty Participants in the Event



Fig 4. Participants attending the Test session



Fig 5. Participant Feedback about the event

  
Co-ordinator

  
Signature of HOD, ECE

Professor & Head  
Dept. of Electronics & Communication Engg.  
K. S. School of Engineering & Management  
Bangalore-560 109



Report on

Project Exhibition-2022-2023

Department of Electronics and Communication Engineering Organized Project Exhibition on 8<sup>th</sup> May 2023. All the Final Year Students exhibited their Projects.

Dr. D Jaydevappa, Professor & Head of Department Electronic and Instrumentation Engineering, JSSATE, Bangalore and Mr. Mahabaleswar Bhatt, Associate Director, R&D, KSGL, Bangalore were the Judge for the event. There were 26 Projects from ECE Department and 4 Projects from EEE Department. The following Teams were declared as the Winners.

Sl No	Team No	Dept	USN	Name of the Student	Project Title	Guide Name	Prize
1	T-14	ECE	1KG19EC067	NIRIKSHA V MURTHY	Design and fabrication of a prototype for knee rehabilitation	Dr. K Senthil Babu	First
			1KG19EC068	NITHIN L			
			1KG19EC073	PRAJWAL S K			
			1KG19EC078	PRATYUSH KUMAR			
2	T-24	ECE	1KG19EC001	AAFIYA KULSOOM	Smart Shopping Trolley with Automated Billing	Dr. Girish V. Attimarad	Second
			1KG19EC011	BHAGYALAKSHMI J H			
			1KG19EC013	BHAVANA S			
			1KG19EC048	KARUNA S			
3	T-	EEE	1KG19EE001	Anush K C	Design and Development of Power Generation Model Using Urban Waste	Mrs. Tejaswini G V	First
			1KG19EE007	Sharan G			
			1KG19EE008	Sharath N			
4	T-	EEE	1KG19EE003	Gowtham R	Soft Switch Operated Interleaved Boost Converter	Mrs. Hemapriya M	Second
			1KG19EE006	Sanjay P Swamy			
			1KG19EE401	Bhavana G			
			1KG20EE403	Nirosha G M			





Kammavari Sangham (R) 1952  
K. S. GROUP OF INSTITUTIONS

**K. S. SCHOOL OF ENGINEERING AND MANAGEMENT**  
Approved by AICTE, New Delhi; Affiliated to VTU, Belagavi, Karnataka; Accredited by NAAC  
www.kssem.edu.in

**KSSEM**  
K. S. SCHOOL OF ENGINEERING AND MANAGEMENT

**DEPARTMENT OF ELECTRONICS AND COMMUNICATION ENGINEERING**



Fig 1: Inauguration of Project Exhibition



Fig 2: Students present in the Project Exhibition





Kammavari Sangham (R) 1952  
K. S. GROUP OF INSTITUTIONS

**K. S. SCHOOL OF ENGINEERING AND MANAGEMENT**  
Approved by AICTE, New Delhi; Affiliated to VTU, Belagavi, Karnataka; Accredited by NAAC

www.kssem.edu.in

**KSSEM**  
K. S. SCHOOL OF ENGINEERING AND MANAGEMENT

**DEPARTMENT OF ELECTRONICS AND COMMUNICATION ENGINEERING**



Fig 3: Students Explaining about their Projects to the examiners



Fig 4: Students awarded first and second prize in Project exhibition

**Signature of HoD, ECE**

Professor & Head

Dept. of Electronics & Communication Engineering

K. S. School of Engineering & Management

Bangalore-560 109





Report on

Farewell Day Celebration

Department of Electronics and Communication Engineering has been organized a Farewell event to final year 2022-2023 batch students on 22<sup>nd</sup> May 2023. On this special occasion the event was presided by the Dr. Rama Narasimha, Principal, KSSEM, Dr. K Senthil Babu, Head of the Department along with all other faculties and supporting staff and students.

The event began with a formal inauguration, followed by, the Principal and HoD addressed the gathering and wish for their betterment of future. Students and faculties shared their memories and gave inputs about the life values, work ethics and how to survive in the competition world. Students also express their gratitude to the teachers.

Cultural Activities was organized for the final year students from 3<sup>rd</sup> and 2<sup>nd</sup> year. Students Refreshments were arranged for all students and faculties.



**Fig 1:** Inauguration of Farewell Day Celebration



**KSSEM**  
K. S. SCHOOL OF ENGINEERING AND MANAGEMENT

Kammavari Sangham (R) 1952  
K. S. GROUP OF INSTITUTIONS

**K. S. SCHOOL OF ENGINEERING AND MANAGEMENT**  
Approved by AICTE, New Delhi; Affiliated to VTU, Belagavi, Karnataka; Accredited by NAAC

www.kssem.edu.in

**DEPARTMENT OF ELECTRONICS AND COMMUNICATION ENGINEERING**



Fig 2: Faculties and Students Present in the Celebration



Fig 3: Cultural activity by 4<sup>th</sup> Sem Students



Fig 4: Feedback from Final Year Student

Signature of HoD

Professor & Head  
of Electronics & Communication Engineering  
K. S. School of Engineering & Management  
Bangalore-560 109





**KSSEM**  
K. S. GROUP OF INSTITUTIONS

KammavariSangham (R) 1952

K. S. GROUP OF INSTITUTIONS

**K. S. SCHOOL OF ENGINEERING AND MANAGEMENT**

Approved by AICTE, New Delhi; Affiliated to VTU, Belagavi, Karnataka; Accredited by NAAC

www.kssem.edu.in

**DEPARTMENT OF ELECTRONICS AND COMMUNICATION ENGINEERING**

## Report on

# Hands on Training on Interfacing of Sensors



Organized by IEEE Student Branch, KSSEM

In association with IEEE Bangalore section.

Topic: Hands on Training on Interfacing of Sensors

Date of event: 21<sup>st</sup> May, 2023

Venue: Aryabhata Seminar Hall, Dept of ECE, KSSEM

Number of participants: 60

Targeted Audience: 3<sup>rd</sup> year ECE students

Event Coordinator: Dr. Girish V Attimarad, Professor, ECE Dept, KSSEM

Mrs. Ravikiran B A, Asst Prof, ECE Dept, KSSEM

The IEEE Student branch in association with the ECE department, of KSSEM, had organized a Hand on training on, "Interfacing of Sensors" on 21<sup>st</sup> May, 2023 at 9:30am IST.

The Hands on Training was conducted at K.S School of Engineering & Management, Bangalore. The training was given by Mr Rahul Kumar A and Mr Bharath Gowda P S, Founder and Engineer, Inversa Technosoft. Dr Ramanarasimha, Principal, Dr.K Senthil Babu, HoD of ECE, graced the event with their presence. The Hands on training was attended by both faculty members and students.

The objective of the training is given below;

- To introduce the students to various commonly used sensors and their working principles;
- To interface the sensors with microcontrollers and write simple code to acquire data from the sensors.
- To formulate applications based on the knowledge acquired.





### Topics Covered:

The training covered various aspects of interfacing. Some of the topics discussed were:

- Introduction to Arduino Microcontroller
- Different types of Arduinos
- Interfacing RGB to LED using Arduino
- Interfacing IR Sensor
- Interfacing ultrasonic sensors
- Interfacing LDR using Arduino

At last all the students discussed about their mini project individually.

### Introduction to Arduino Microcontroller

Arduino is an open-source project that created microcontroller-based kits for building digital devices and interactive objects that can sense and control physical devices.

### Different types of Arduinos

- 1) **UNO and MKR** is fairly beginner friendly, with the more expensive MKR offering greater connectivity (WiFi and Bluetooth) options.
- 2) **Mega** is good for robotics projects, including CNC machines and 3D printers.
- 3) **Nano** families are cost effective alternatives to the MKR, and are good for networks of sensors.
- 4) **Due** is good for efficient graphics and sound processing.
- 5) **Leonardo and Micro** are good alternatives to the UNO, particularly for USB connectivity.
- 6) **Yun** offers an embedded Linux system which can function as a multi-tasking server
- 7) **Portenta** is incredibly powerful.

### Interfacing RGB to LED using Arduino

RGB LEDs consist of one red, one green, and one blue LED. By independently adjusting each of the three, RGB LEDs are capable of producing a wide color gamut. Unlike dedicated-color LEDs, these do not produce pure wavelengths. Modules may not be optimized for smooth color mixing.

### Interfacing IR Sensor

The IR sensor has a **3-pin** connector that interfaces it to the outside world. The connections are as follows: **VCC** is the power supply pin for the IR sensor which we connect to the 5V pin on the Arduino. **OUT** pin is a 5V TTL logic output. **LOW** indicates no motion is detected, **HIGH** means motion is detected.





### Interfacing Ultrasonic sensors

To interface an ultrasonic sensor with an Arduino board, you need to connect the Vcc pin to the 5V pin and the GND pin to the ground (GND) pin of the Arduino board. The Trigger pin of the sensor should be connected to a digital pin of the Arduino board.

### Interfacing LDR using Arduino

LDR sensor module is used to detect the intensity of light. It is associated with both analog output pin and digital output pin labeled as AO and DO respectively on the board. When there is light, the resistance of LDR will become low according to the intensity of light. The greater the intensity of light, the lower the resistance of LDR. The sensor has a potentiometer knob that can be adjusted to change the sensitivity of LDR towards light.

Finally with all the interfacing connections the objective of the hands on training session was achieved and also the hands on training were organized for the skill development which was achieved. Students cleared their doubts and were sure about the connections of Arduino.



Fig 1. Inauguration of Hands on training on interfacing of sensors





KammavariSangham (R) 1952  
K. S. GROUP OF INSTITUTIONS

**K. S. SCHOOL OF ENGINEERING AND MANAGEMENT**  
Approved by AICTE, New Delhi; Affiliated to VTU, Belagavi, Karnataka; Accredited by NAAC  
www.kssem.edu.in



**DEPARTMENT OF ELECTRONICS AND COMMUNICATION ENGINEERING**



Fig 2. Students Interfacing various sensors and to Arduino



Fig 3. Principal, Guest Speaker, Faculties and Students present in the Event

Coordinator

Signature of HoD, ECE

Professor & Head  
Dept. of Electronics & Communication Engineering,  
K. S. School of Engineering & Management  
Bangalore-560 109





## A Report on Industrial Visit-GTTC, Dandeli

Department of Electronics and Communication Engineering has organized an industrial Visit to Government Tool Room and Training Centre (GTTC), Dandeli for the sixth-semester students on 2/06/2023. The faculties Dr. Manu D K and Mrs. Renuka V Tali accompanied the students during the visit to Dandeli.

### **AIM of Industrial Visit:**

Industrial visit is considered one of the tactical methods of teaching. The main reason behind this- it lets the student know things practically through interaction, working methods, and employment practices.

Moreover, it gives exposure from an academic point of view.

The main aim of industrial visits is to provide exposure to students to the practical working environment. They also provide students with a good opportunity to gain full awareness of industrial practices. Through industrial visits, students get awareness about new technologies. Technology development is the main factor, of which students should have good knowledge.

Visiting different companies help students to build a good relationship with those companies. We know building a relationship with companies always will help us to gain a good job in the future. After visiting, industry students can gain a combined knowledge about both theory and practical. Students will be more concerned about earning a job after having an industrial visit.

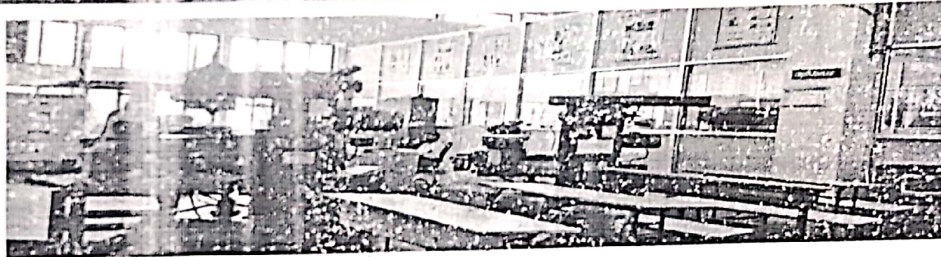




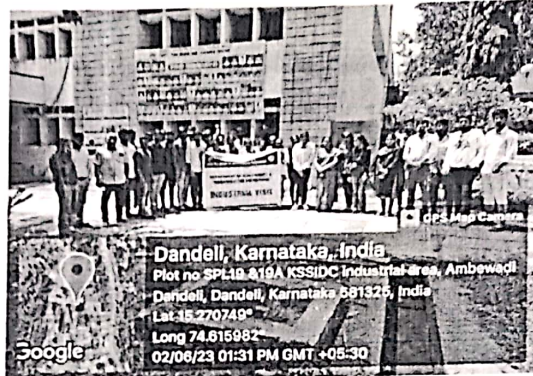
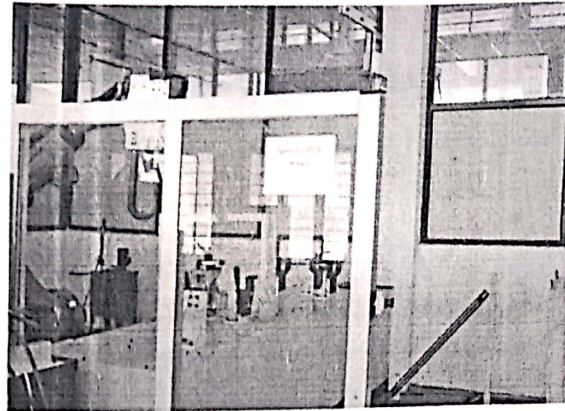
Government Tool Room & Training Centre (GTTC) Dandeli is established by the government of Karnataka in 1994 and is located at Ambewadi Industrial Estate, Dandeli. GTTC is at the forefront of offering highly practical-oriented training courses in Design, Analysis, and production aspects of Tools, Dies & Molds, Precision Manufacturing & Mechatronics. These courses address the growing demand for high-quality technical human resource requirements across the manufacturing sector. With an emphasis on Teacher-Trainee engagement, following best-in-class traditions of the learning process, GTTC Dandeli celebrated its silver jubilee function in 2019.

It offers many training and certification courses on Industrial robotics, CAD, IOT, Automation, etc. The staff demonstrated working on embedded, automation, robotic machines, and 3D printing machines.

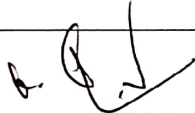
Students enjoyed the ambiance and explored various industry-oriented lab equipment.







Industry Visited	GTTC(Government Tool Room and Training Centre),Dandeli
Date	02 <sup>nd</sup> June 2023
Transportation	Bus (One)
Students	Total of 30 students (SEM VI ECE)
Faculty Accompanied	Dr. Manu D K Mrs. Renuka V Tali
Department Industrial Visit Coordinator	Dr. Manu D K, Associate Professor, Dept. of ECE, KSSEM

  
Signature of HoD, ECE

Professor & Head  
Dept. of Electronics & Communication Engineering  
K. S. School of Engineering & Management  
Bangalore-560 109

## Industrial Visit Dandeli Itinerary

### 1. Day 1: 01/06/2023(Thursday)

Starting from KSSEM campus at around 7:30 pm.

### 2. Day 2: 02/06/2023 (Friday)

Early morning reaching stay place at Dandeli by 7:00am

Breakfast: 8.30AM

**INDUSTRIAL VISIT: GTTC (Govt. Tool Room & Training Center),  
Dandeli.**

Time: 10am to 12pm

Then back to stay place and night stay.

### 3. Day 3:03/06/2023 (Saturday)

Morning breakfast visit to local village and places.

Then return to stay place and stay.

### 4. Day 4 :04/06/2023 (Sunday)

After Breakfast Travelling back to Bangalore

Evening drop at college (KSSEM) within 5pm.

*Manu*  
*25/5/23*



Professor & Head  
Dept. of Electronics & Communication Engineering  
K. J. Somaiya School of Engineering & Management  
Bangalore-560 109



# SEMINAR **TOP 3 CAREERS** TO PURSUE AFTER ENGINEERING

In association with  
K S School of Engineering & Management  
Dept. of Electronics & Communication Engg.  
HoD: Dr. K Senthil Babu  
Faculty Coordinator: Ms. Swati Sarkar



3<sup>rd</sup> Aug'23 Thursday



11:30 AM onwards



**Venue:** Holiday Village Road, Vajarahalli Village,  
Mallasandra, Off Kanakapura Rd, Bengaluru 560109



**Mr. Vipin Kumar Mishra**

GATE Expert  
Lead Mentor-IMS  
12+ Yrs. of Teaching Exp.





## Report on

# Top 3 Careers to pursue after Engineering.

**Topic:** Top 3 Careers to pursue after Engineering.

**Date of event:** 3-8- 2023

**Venue:** Aryabhata Seminar Hall, Dept of ECE, KSSEM

**Number of participants:** 110

**Targeted Audience:** 2<sup>nd</sup> year ECE students

A seminar on “Top 3 Careers to Pursue after Engineering” was conducted by MR. Vipin Kumar Mishra from IMS GATE Academy, for students of 4<sup>th</sup> Semester ECE on 3<sup>rd</sup> August 2023, at the Aryabhata Seminar Hall in KSSEM. The main aim of the talk was to inform the students about the opportunities available for the students after graduating from the Bachelors Program in Engineering, and the different competitive examinations to be taken up in pursuit of these careers. The talk focused on the various competitive and qualifying examinations that can be taken up for higher education and/or careers in private and public sector industries in India and Abroad, and the preparations needed to clear these examinations. The following report includes further details regarding the same.

The purpose of this report is to outline the main aim and goal of qualifying in the GATE exam, with the objective of securing a government job, preferably in a PSU. The seminar delved into the comparison of GATE with JEE Mains and Advance, discuss higher education options at NITIE Mumbai, shed light on the opportunity of a fellowship program in management through GATE, explore possibilities of pursuing education abroad, and details of the coaching course offered by IMS GATE Academy.

The primary aim of many ambitious students is to qualify for the GATE exam to gain eligibility for various government job opportunities. GATE scores are widely accepted by PSUs, making it a preferred route for job seekers aiming for a secure career in the public sector.

Over time, many students have highlighted that they find GATE to be easier than JEE Mains and Advance, indicating their relative confidence in their preparation for the GATE exam. This statement suggests that the student believes they have a better chance of qualifying for the GATE exam compared to the highly competitive JEE Mains and Advance exams.



The seminar also highlighted the opportunity to get into universities such as NUS and NTU, which could be potential options for pursuing education abroad using GATE scores.

The students were also informed about the GRE exam, which is a standardized test required for admission to graduate programs in various universities worldwide. While not directly related to GATE, the mention of GRE indicated that the student might be exploring broader opportunities beyond India for higher studies.

### IMS GATE Academy Coaching Course:

IMS GATE Academy offers an 18-month coaching course for GATE entrance preparation. This suggests that the student is considering professional coaching to enhance their chances of qualifying the GATE exam successfully.

### Conclusion:

This talk highlighted the student's main aim of qualifying the GATE exam to secure a government job, preferably in a PSU. It explored the comparison of GATE with JEE Mains and Advance, higher education at NITIE Mumbai, the availability of a fellowship program in management through GATE, possibilities of education abroad, and their consideration of IMS GATE Academy coaching. The report provides an overview of the student's aspirations and efforts to achieve their career goals through GATE

**IMS GATE ACADEMY**  
www.imsindia.com/gate

**SEMINAR  
TOP 3 CAREERS  
TO PURSUE AFTER  
ENGINEERING**

In association with  
K S School of Engineering & Management  
Dept. of Electronics & Communication Engg.  
HoD Dr. K Senthil Babu  
Faculty Coordinator Ms. Swati Sarkar

3<sup>rd</sup> Aug'23 Thursday  
11:30 AM onwards

**Mr. Vipin Kumar Mishra**  
GATE Expert  
Lead Mentor-IMS  
12+ Yrs of Teaching Exp.

Bengaluru, Karnataka, India  
K S School Of Engineering And Management Engineering Block, off,  
Kanakapura Rd, Bengaluru, Mallasandra, Karnataka 560109, India  
Lat 12.859348°  
Long 77.542716°  
03/08/23 11:52 AM GMT +05:30


Fig 1. Guest Speaker addressing the event





Fig 2. Guest Speaker and Students present in the Event

  
Coordinator

  
Signature of HoD, ECE  
Professor & Head  
Dept. of Electronics & Communication Engineering  
K.S. School of Engineering & Management  
Bangalore - 560 109.





**KSSEM**  
K. S. SCHOOL OF ENGINEERING AND MANAGEMENT

Kammavari Sangham (R) 1952

**K. S. GROUP OF INSTITUTIONS**

**K. S. SCHOOL OF ENGINEERING AND MANAGEMENT**

Approved by AICTE, New Delhi; Affiliated to VTU, Belagavi, Karnataka; Accredited by NAAC

[www.kssem.edu.in](http://www.kssem.edu.in)

**DEPARTMENT OF ELECTRONICS AND COMMUNICATION ENGINEERING**

## Report on

### **Sports Day for 4<sup>th</sup> sem ECE Students**

The sports students of ECE 4<sup>th</sup> semester actively participated in a department sports activity on 5<sup>th</sup> August 2023 (Saturday) as a part of Physical Education (PE)(Sports and Athletics) NMDC 21PE83, VTU 2021 scheme syllabus in K S School and engineering and Management campus. Students were involved various sports activities like Badminton, Table tennis, Chess, Carrom, Kabbadi, Volleyball and also Cricket. All the students participated with enthusiasm and team spirit .







**KSSEM**  
K. S. SCHOOL OF ENGINEERING AND MANAGEMENT

Kammavari Sangham (R) 1952

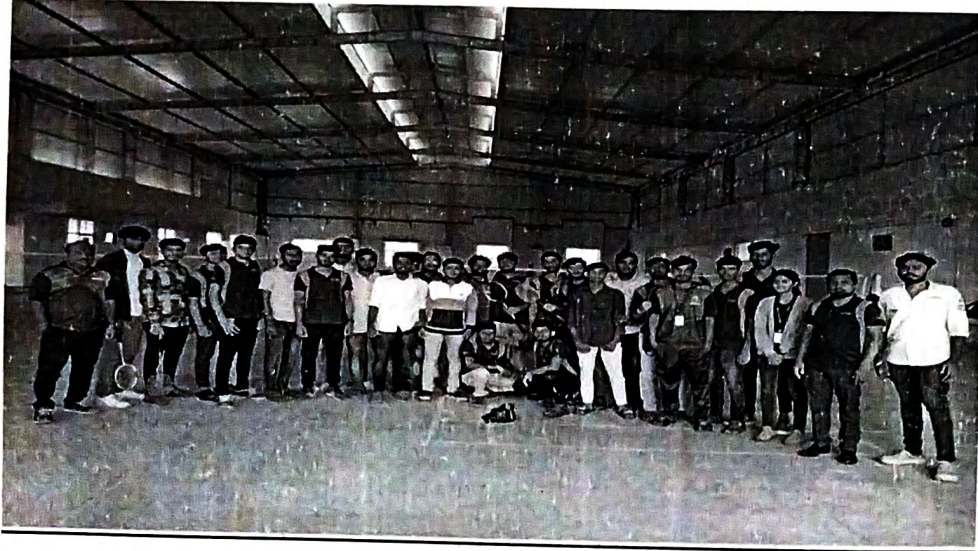
**K. S. GROUP OF INSTITUTIONS**

**K. S. SCHOOL OF ENGINEERING AND MANAGEMENT**

Approved by AICTE, New Delhi; Affiliated to VTU, Belagavi, Karnataka; Accredited by NAAC

[www.kssem.edu.in](http://www.kssem.edu.in)

**DEPARTMENT OF ELECTRONICS AND COMMUNICATION ENGINEERING**







Kammavari Sangham (R) 1952

K. S. GROUP OF INSTITUTIONS

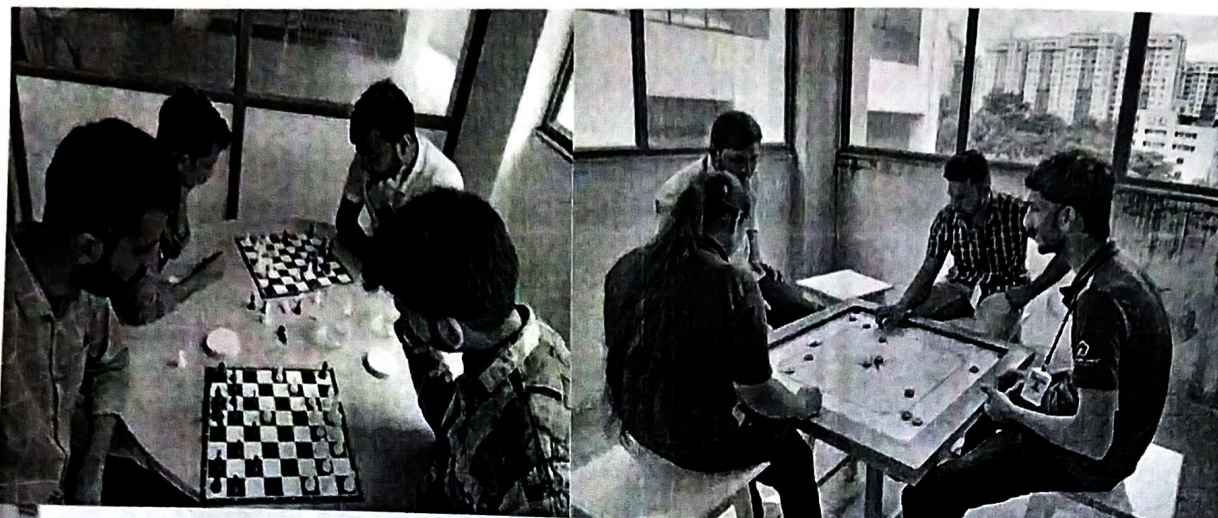
# K. S. SCHOOL OF ENGINEERING AND MANAGEMENT

Approved by AICTE, New Delhi; Affiliated to VTU, Belagavi, Karnataka; Accredited by NAAC

[www.kssem.edu.in](http://www.kssem.edu.in)

**KSSEM**  
SCHOOL OF ENGINEERING AND MANAGEMENT

**DEPARTMENT OF ELECTRONICS AND COMMUNICATION ENGINEERING**



Sports Co-ordinator

Dr. Manu D K

Signature of HoD

**Professor & Head**

Dept. of Electronics & Communication Engineering  
K.S. School of Engineering & Management  
Bangalore - 560 109.





**KSSEM**  
K.S. SCHOOL OF ENGINEERING AND MANAGEMENT

Kammavari Sangham (R) 1952  
K. S. GROUP OF INSTITUTIONS

**K. S. SCHOOL OF ENGINEERING AND MANAGEMENT**  
Approved by AICTE, New Delhi; Affiliated to VTU, Belagavi, Karnataka; Accredited by NAAC  
#15, Near Vajarahalli, Mallasandra, off kanakapura Road, Bengaluru - 560109  
Tel: +91 8028425012/013/163, Fax: +91 80 28425164, Mob: 88844444408 / 9606055906  
[www.kssem.edu.in](http://www.kssem.edu.in)

**“Organic Farming, Indian Agriculture (Past, Present &  
Future) Connectivity for Marketing”**

On

**5<sup>th</sup> August 2023**

by

**KSSEM, Bengaluru - 560109**

Association with



**NATIONAL SERVICE SCHEME (NSS)**

**K.S. School of Engineering and Management**

**Bengaluru - 560109**





## **K. S. SCHOOL OF ENGINEERING AND MANAGEMENT**

Approved by AICTE, New Delhi; Affiliated to VTU, Belagavi, Karnataka; Accredited by NAA

#15, Near Vajarahalli, Mallasandra, off kanakapura Road, Bengaluru – 560109

Tel: +91 8028425012/013/163, Fax: +91 80 28425164, Mob: 88844444408 / 9606055906

[www.kssem.edu.in](http://www.kssem.edu.in)

The NSS Cell of KSSEM Conducted **Organic Farming, Indian Agriculture (Past, Present & Future) Connectivity for Marketing** on 5/08/2023 at **Art of Living, Bengaluru**. The NSS Students of Electronics and Communication Engineering participated with great enthusiasm.

We conducted the event with great help by our Management, R. Rajagopal Naidu, President, KSGL, R. Leela Shankar Rao, Secretary, KSGL, T Neerajakshulu Naidu, Treasurer, KSGL, Dr. KVA Balaji, CEO, KSGL, Dr. K. Rama Narasimha, Principal/ Director, KSSEM, Dr. Senthil Babu, Professor & Head, Electronics and Communication Engineering and NSS Faculty coordinators.

The primary objective of NSS Programme was to educate the students about the main principles and practices of organic food production are to inspire and enhance biological cycles in the farming system, keep and enhance deep-rooted soil fertility, reduce all types of pollution, evade the application of pesticides and synthetic fertilizers, conserve genetic diversity in food.

The NSS students assembled at 9am at the KSSEM campus, where they were divided into six groups, each designated for different activities. Students left the college by bus at 9.30am and reach the Art of Living at 10.15am. The students were warmly welcomed by the authorities and staff of Art of Living. Then students are educated on following.

- Educating on different breeds of cows
- Cleaning
- Teaching on Organic Farming
- Marketing





**KSSEM**  
K. S. SCHOOL OF ENGINEERING AND MANAGEMENT

Kammavari Sangham (R) 1952

**K. S. GROUP OF INSTITUTIONS**

## **K. S. SCHOOL OF ENGINEERING AND MANAGEMENT**

Approved by AICTE, New Delhi; Affiliated to VTU, Belagavi, Karnataka; Accredited by NAAC

#15, Near Vajarahalli, Mallasandra, off kanakapura Road, Bengaluru – 560109

Tel: +91 8028425012/013/163, Fax: +91 80 28425164, Mob: 88844444408 / 9606055906

[www.kssem.edu.in](http://www.kssem.edu.in)

### Educating on different breeds of cows

There are many different breeds of cows are grown in the Art of Living. They taught our students about different variety breeds of cows. Namely Gir, Red Sindhi, Sahiwal, Hallikar, Amritmahal, Khillari, Bargur, Pulikulam, Tharparkar, Kankrej, Rathi Cow, Tharparkar Cow and many more.

#### Gir cow

Gir cattle are indigenous to the Gir hills and forests of Kathiawar. The Gujarat districts of Amreli, Bhavnagar, Junagadh, and Rajkot are included. The breed gets its name from the Gir forest, which is the breed's natural habitat. In different parts of their breeding tract, the breed is also known by other names. Bhodali, Gujarati, Sorthi, Surti, Kathiawari, and Desan are some examples.

#### Sahiwal Cow

The Sahiwal cattle breed originated in undivided India's Montgomery region (now in Pakistan). Lola, Lambi Bar, Teli, Montgomery, and Multani are some other names for this cattle breed. The best indigenous dairy breed in the country is Sahiwal. Sahiwal milk yields between 1400 and 2500 kilograms per lactation on average. Many parts of India, including Haryana, Punjab, Delhi, and Uttar Pradesh, have it.

Sahiwal is a reddish brown to red color with varying amounts of white on the neck and underline. The color darkens towards the head, neck, legs, and tail of male breeds. This breed is also known for having droopy ears. The hump is quite large in males, but it is negligible in females. So that's why Sahiwal cow is the #2 best cow breed in india.

#### Red Sindhi Cow

The majority of red Sindhis live in the neighboring Pakistani districts of Karachi and Hyderabad. Sindhi and Red Karachi are other names for it. This cattle breed's body color is primarily red, with shades ranging from dark to light red and white stripes.





**KSSEM**  
K. S. SCHOOL OF ENGINEERING AND MANAGEMENT

Kammavari Sangham (R) 1952

**K. S. GROUP OF INSTITUTIONS**

**K. S. SCHOOL OF ENGINEERING AND MANAGEMENT**

Approved by AICTE, New Delhi; Affiliated to VTU, Belagavi, Karnataka; Accredited by NAAC

#15, Near Vajarahalli, Mallasandra, off kanakapura Road, Bengaluru – 560109

Tel: +91 8028425012/013/163, Fax: +91 80 28425164, Mob: 88844444408 / 9606055906

[www.kssem.edu.in](http://www.kssem.edu.in)

Its milk yield varies between 1100 and 2600 kilograms. Red Sindhi is popular in crossbreeding programs. So that's why Red sindhi cow is the #3 best cow breed in india.

### Kankrej Cow

Kankrej cattle are a Zebu cattle breed. They originated in the Kankrej Taluka of the Banaskantha district of Gujarat, India. And the breed gets its name from its native land, Kankrej. Kankrej cattle have a short face, a broad forehead, and a slightly dished center. Their nose is slightly turned up.

The hump, forequarters, and hindquarters of bulls are darker than the barrel. They have lyre-shaped, powerful horns. In addition, their horns are skinnier than those of other breeds. Kankrej cows produce an average of 1738 kg over a lactation period ranging from 257 to 350 days.

### Tharparkar Cow

Tharparkar is one of India's top five milking cattle. It is a dual-purpose cattle breed that is disease resistant. Thar is derived from Thul, the general term for the region of the sand, and Parkar means "to cross over" in Arabic. The region was previously known as Thar and Parkar, but Thar and Parkar were later combined into one word.

The breed is also known as "White Sindhi," "Cutchi," and "Thari," depending on where it originated. Tharparkar cattle are medium-sized with lyre-shaped horns. Their skin tone is white/light gray. The bullocks can be used for plowing and casting. Furthermore, it produces 1800 to 2600 kilograms of milk per lactation. So that's why Tharparkar cow is the #8 best cow breed in india.





Kammavari Sangham (R) 1952  
K. S. GROUP OF INSTITUTIONS

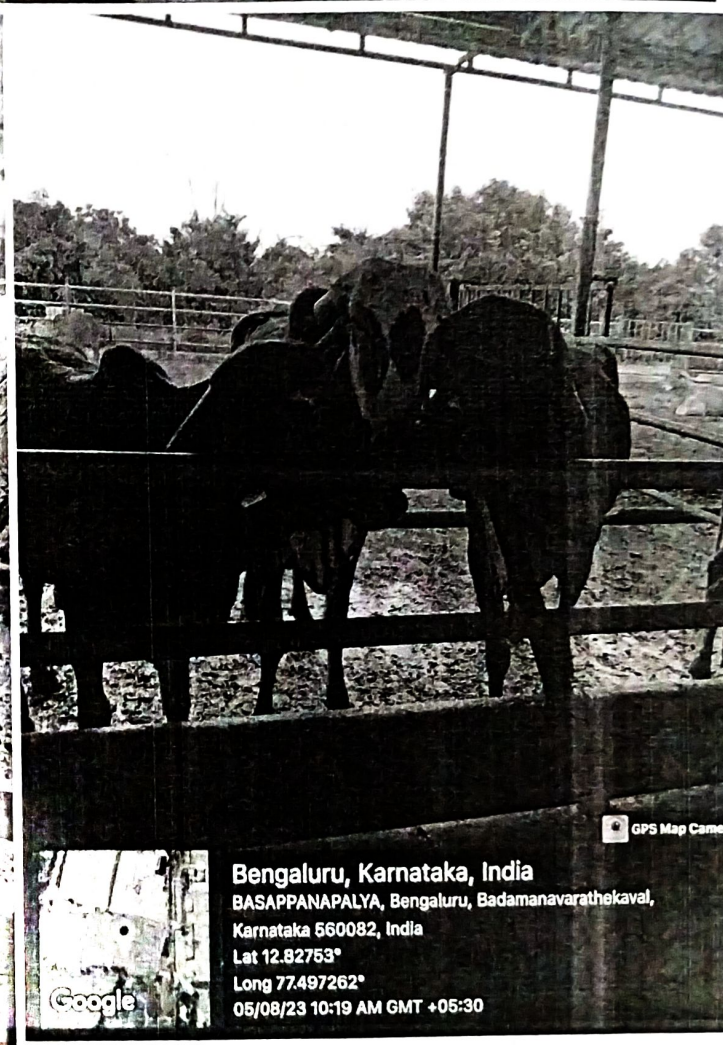
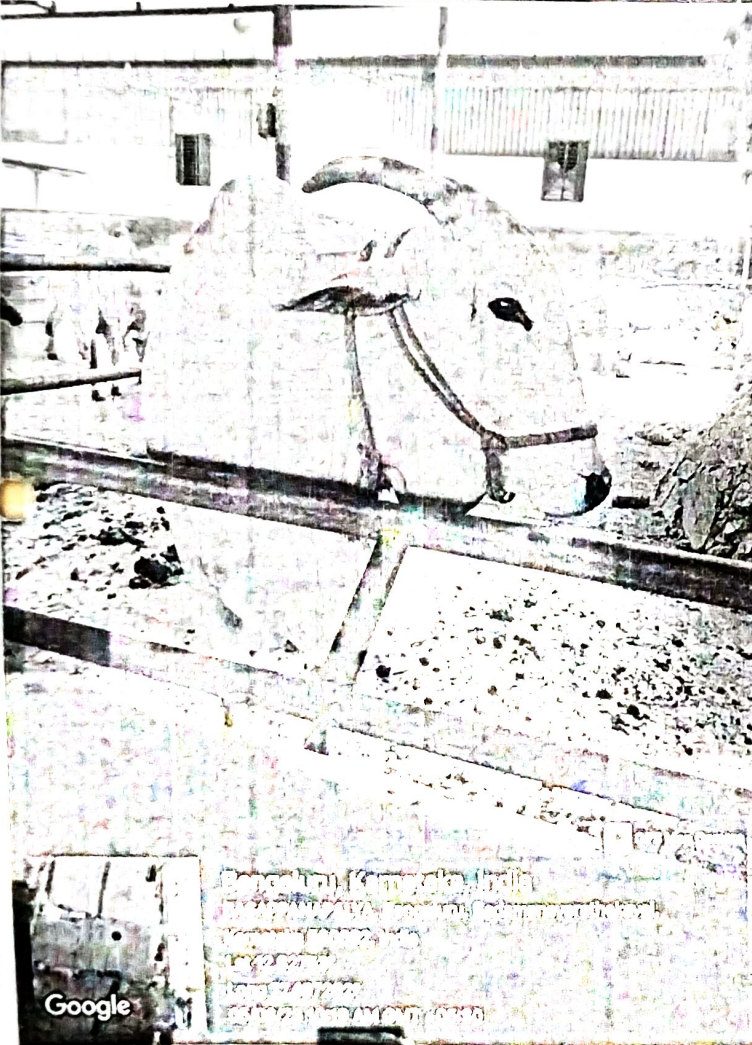
# K. S. SCHOOL OF ENGINEERING AND MANAGEMENT

Approved by AICTE, New Delhi; Affiliated to VTU, Belagavi, Karnataka; Accredited by NAAC  
#15, Near Vajarahalli, Mallasandra, off kanakapura Road, Bengaluru - 560109

Tel: +91 8028425012/013/163, Fax: +91 80 28425164, Mob: 88844444408 / 9606055906

[www.kssem.edu.in](http://www.kssem.edu.in)

**KSSEM**  
K.S. SCHOOL OF ENGINEERING AND MANAGEMENT







**KSSEM**  
K.S. SCHOOL OF ENGINEERING AND MANAGEMENT

Kammavari Sangham (R) 1952  
K. S. GROUP OF INSTITUTIONS

**K. S. SCHOOL OF ENGINEERING AND MANAGEMENT**  
Approved by AICTE, New Delhi; Affiliated to VTU, Belagavi, Karnataka; Accredited by NAAC  
#15, Near Vajarahalli, Mallasandra, off kanakapura Road, Bengaluru – 560109  
Tel: +91 8028425012/013/163, Fax: +91 80 28425164, Mob: 88844444408 / 9606055906  
www.kssem.edu.in

### Cleaning the Area

The students have cleaned the area of the cows where they sit and sleep. The students have collected the cow dung and put it on the tractor, it helps to prevent the mosquitoes and other creatures.

Hygiene of the cows, directly linked with environment hygiene, is of great importance in mastitis control and prevention. Again with the prevention of a build up of mastitis pathogens in mind, it is important to keep dry cow pens as clean as possible.



GPS Map Camera

Bengaluru, Karnataka, India  
RFHX+76, Bengaluru, Karnataka 560082, India  
Lat 12.827768°  
Long 77.499324°  
05/08/23 11:10 AM GMT +05:30



GPS Map Camera

Bengaluru, Karnataka, India  
RFHX+76, Bengaluru, Karnataka 560082, India  
Lat 12.82778°  
Long 77.499321°  
05/08/23 11:12 AM GMT +05:30



GPS Map Camera

Bengaluru, Karnataka, India  
RFHX+76, Bengaluru, Karnataka 560082, India  
Lat 12.827827°  
Long 77.499242°  
05/08/23 11:12 AM GMT +05:30



GPS Map Camera

Bengaluru, Karnataka, India  
RFHX+76, Bengaluru, Karnataka 560082, India  
Lat 12.827901°  
Long 77.499209°  
05/08/23 11:12 AM GMT +05:30





**KSSEM**  
K. S. SCHOOL OF ENGINEERING AND MANAGEMENT

Kammavari Sangham (R) 1952

**K. S. GROUP OF INSTITUTIONS**

# **K. S. SCHOOL OF ENGINEERING AND MANAGEMENT**

Approved by AICTE, New Delhi; Affiliated to VTU, Belagavi, Karnataka; Accredited by NAAC

#15, Near Vajarahalli, Mallasandra, off kanakapura Road, Bengaluru – 560109

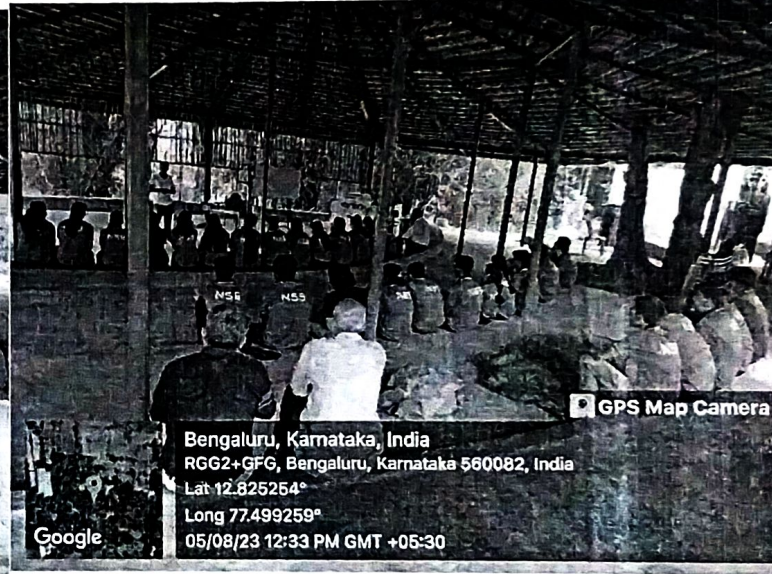
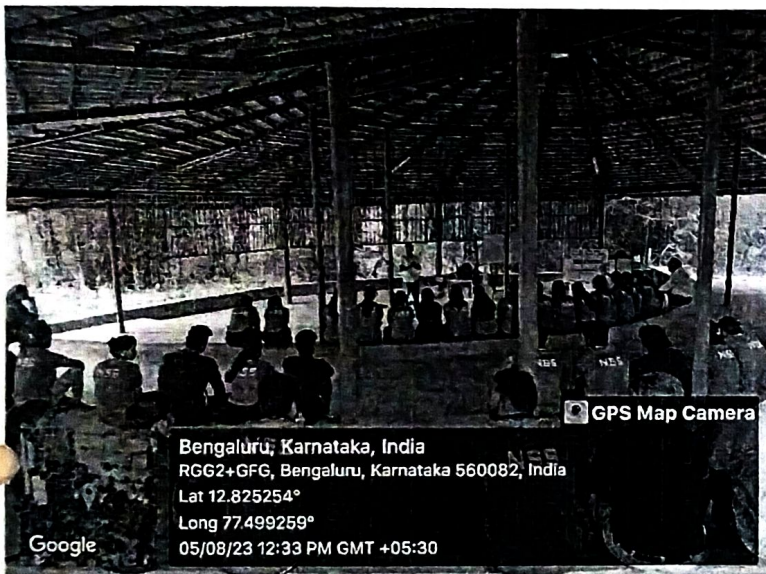
Tel: +91 8028425012/013/163, Fax: +91 80 28425164, Mob: 88844444408 / 9606055906

[www.ksem.edu.in](http://www.ksem.edu.in)

## Teaching on Organic Farming and Marketing

Organic agriculture can be defined as "an integrated farming system that strives for sustainability, the enhancement of soil fertility and biological diversity while, with rare exceptions, prohibiting synthetic pesticides, antibiotics, synthetic fertilizers, genetically modified organisms, and growth hormones.

organic farming, sustainable agricultural system that uses ecologically based pest controls and biological fertilizers derived largely from animal and plant wastes and nitrogen-fixing cover crops. Modern organic farming was developed as a response to the environmental harm caused by the use of chemical pesticides and synthetic fertilizers in conventional agriculture, and it has numerous ecological benefits.



**NSS Programme Officer**

**MANOHARKUMAR K N**

NSS Program Officer

K S School of Engineering and Management  
Bengaluru - 560 109

**Principal**

**Dr. K. RAMA NARASIMHA**

Principal/Director

K S School of Engineering and Management  
Bengaluru - 560 109





KammavariSangham (R) 1952  
K. S. GROUP OF INSTITUTIONS

**K. S. SCHOOL OF ENGINEERING AND MANAGEMENT**  
Approved by AICTE, New Delhi; Affiliated to VTU, Belagavi, Karnataka; Accredited by NAAC

[www.kssem.edu.in](http://www.kssem.edu.in)

**DEPARTMENT OF ELECTRONICS AND COMMUNICATION ENGINEERING**

## Technical Talk Report on

### Modulation systems in mobile Communication:1G to 5G

**Event name:** Technical Talk

**Topic:** Modulation systems in mobile Communication: 1G to 5G

**Date of event:** 30<sup>th</sup> August, 2023

**Venue:** Civil Auditorium, KSSEM

**Number of participants:** 125

**Targeted Audience:** 2<sup>nd</sup> year ECE students

The department of Electronics and Communication Engineering, KSSEM, had organized a technical talk on, “**Modulation systems in mobile Communication: 1G to 5G**” on 30<sup>th</sup> August, 2023 at 1:20PM IST.

The talk was delivered by Mr. Sasindran M Prabhu. Dr.K Senthil Babu, HoD of ECE, graced the event with his presence. The seminar was attended by both faculty members and students.

The objective of the technical talk was to prepare the students about necessity for using wires in the communication systems.

#### **Abstract:**

Modulation is a fundamental technique in wireless cellular communication systems that enables the transmission of data over radio waves. This report presents an overview of modulation techniques employed in mobile communication systems from the first generation (1G) to the fifth generation (5G), tracing their evolution, types, and impact on wireless communication. Additionally, the report discusses the transformation of cellular networks and the introduction of an all-IP architecture in 4G systems.



**KSSEM**  
K. S. SCHOOL OF ENGINEERING AND MANAGEMENT

KammavariSangham (R) 1952  
K. S. GROUP OF INSTITUTIONS

**K. S. SCHOOL OF ENGINEERING AND MANAGEMENT**  
Approved by AICTE, New Delhi; Affiliated to VTU, Belagavi, Karnataka; Accredited by NAAC  
www.kssem.edu.in

**DEPARTMENT OF ELECTRONICS AND COMMUNICATION ENGINEERING**

## Introduction:

Mobile communication systems have undergone significant evolution over generations, driven by the need for improved data rates, reduced latency, and enhanced network efficiency. Modulation techniques, which encode data into radio signals for transmission, play a central role in this evolution.

## Types of Modulation Techniques:

Modulation techniques fall into two broad categories: analog and digital.

### Analog Modulation:

Analog modulation techniques, used in the 1G era, include Frequency Modulation (FM) and Amplitude Modulation (AM). These techniques involve varying the frequency or amplitude of carrier signals to encode information. However, analog modulation is susceptible to noise and interference, limiting data capacity.

### Digital Modulation:

Digital modulation techniques introduced with 2G and onwards, involve converting digital data into discrete symbols before transmission. Some key digital modulation schemes include:

**Frequency Shift Keying (FSK):** Used in 2G systems, FSK encodes data by varying the carrier frequency between two distinct values.

**Gaussian Minimum Shift Keying (GMSK):** A form of Continuous Phase Frequency Shift Keying (CPFSK), used in 2G, which offers improved spectral efficiency compared to FSK.

**Quadrature Phase Shift Keying (QPSK):** Employed in 3G, QPSK encodes data by varying both the amplitude and phase of the carrier.

**Quadrature Amplitude Modulation (QAM):** Used in 3G and beyond, QAM combines both amplitude and phase variations for higher data rates.

## Evolution of Mobile Communication:

**Analog Modulation:** The first-generation (1G) systems, primarily using analog modulation techniques like Frequency Division Multiple Access (FDMA), provided limited data rates of around 2 kbps.





KammavariSangham (R) 1952

K. S. GROUP OF INSTITUTIONS

**K. S. SCHOOL OF ENGINEERING AND MANAGEMENT**

Approved by AICTE, New Delhi; Affiliated to VTU, Belagavi, Karnataka; Accredited by NAAC

[www.kssem.edu.in](http://www.kssem.edu.in)

**KSSEM**  
K. S. SCHOOL OF ENGINEERING AND MANAGEMENT

**DEPARTMENT OF ELECTRONICS AND COMMUNICATION ENGINEERING**

**Digital Modulation:** The second generation (2G) introduced digital modulation techniques, such as Time Division Multiple Access (TDMA) and Code Division Multiple Access (CDMA), enhancing data rates to 14.4 to 64 kbps.

#### **Wireless Cellular Communication System:**

Wireless cellular communication systems are designed as a network of interconnected cells, each served by a base station. As generations progressed, the density of cells increased to provide higher coverage and capacity. The evolution led to smaller cell sizes, reduced interference, and improved network reliability.

#### **Transition to All-IP Architecture:**

The transition to 4G brought about a paradigm shift with the adoption of an all-IP architecture. This architecture facilitated seamless integration of voice and data services over a unified network, improving efficiency and allowing for a wider range of services and applications.

#### **Conclusion:**

Modulation techniques have been at the forefront of mobile communication evolution, transforming the way data is transmitted and received. From the analog modulation of 1G to the advanced modulation schemes of 5G, each generation has brought about higher data rates, improved spectral efficiency, and enhanced user experiences.

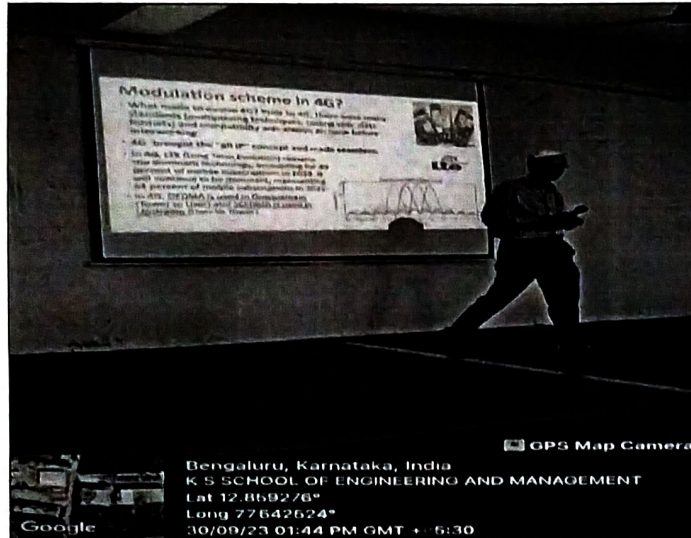
The shift towards an all-IP architecture in 4G further revolutionized the cellular landscape. As 5G continues to unfold, modulation systems remain a pivotal element in shaping the future of wireless communication.

At the end of the technical seminar students were given multiple choice questions based on the session and evaluated the performance of the students.

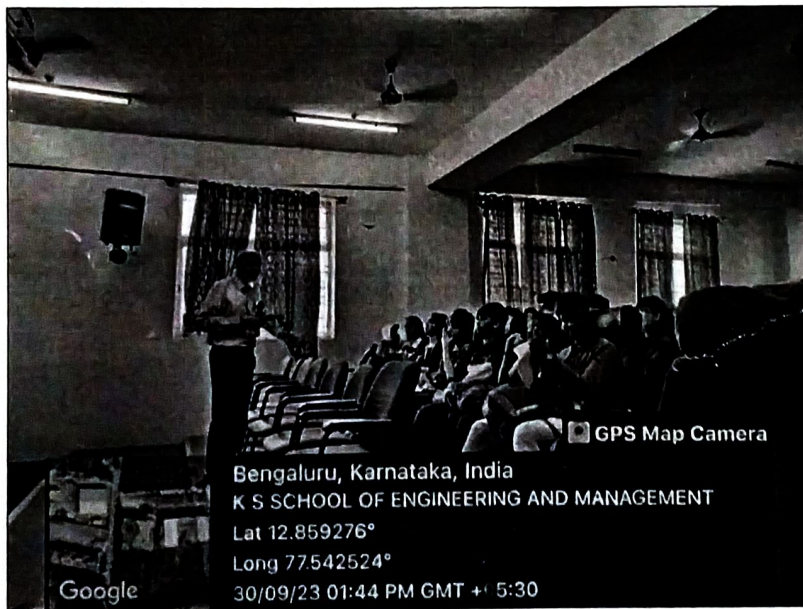


**KSSEM**  
K.S. SCHOOL OF ENGINEERING AND MANAGEMENT

**Photo Gallery:**




**Fig 1. Speaker addressing the Audience**



**Fig 2. Students Participants in the Event**

  
**Co-ordinator**

  
**Signature of HOD, ECE**  
**Professor & Head**  
Dept. of Electronics & Communication Engineering  
K.S. School of Engineering & Management  
Bangalore - 560 109.